

Peripheral Interventional Vascular Diagnostics & Therapy

Catalog

B | BRAUN
SHARING EXPERTISE

B. Braun Vascular Systems

Peripheral Interventional Vascular Diagnostics and Therapy

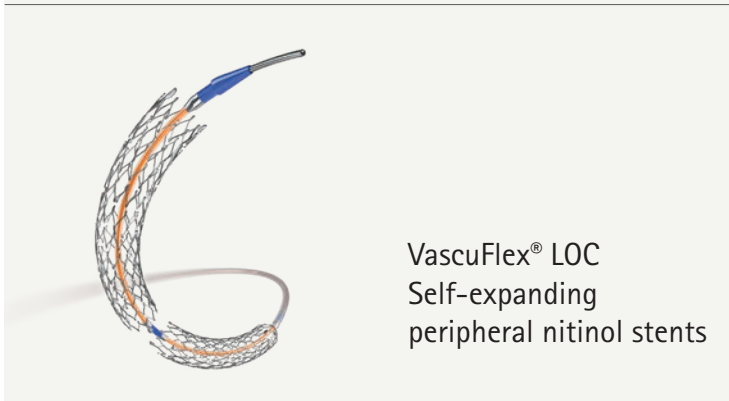
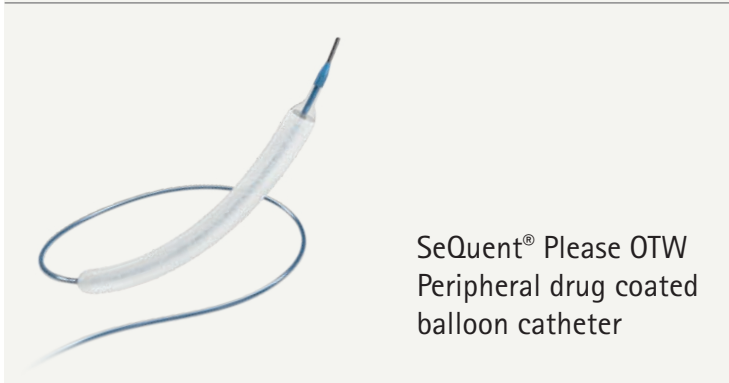

Content

PERIPHERAL ANGIOPLASTY

PTA scoring balloon catheters

4 NSE PTA™

Peripheral drug coated balloon catheters

5 SeQuent® Please OTW

6 SeQuent® Please OTW 014

7 SeQuent® Please OTW 018

8 SeQuent® Please OTW 035

Self-expanding peripheral nitinol stents

9 VascuFlex® Multi-LOC | Spot stenting system

10 – 11 VascuFlex® 2-LOC / 3-LOC | Focal stenting systems

ANGIOGRAPHY

Radiology kits

12 Angiodyn® Customized service

13 Angiodyn® Standard kits

Accessories

14 Angiodyn® guidewires

15 Angiodyn® angiographic syringes

16 Angiodyn® image intensifier covers and bags

PTA Scoring Balloon Catheter



Features

Low entry profile and flexible tip

- Minimizing the tip profile reduces the gap with the wire and provides for better lesion penetration (3)

Flexible free floating elements

- Improved deliverability even in complex lesions (3)
- Provide for high trackability even in tortuous vessels (1)

Triangular shaped elements

- Stabilize the balloon in the lesion during inflation (1)
- Provide an efficacious scoring effect due to high concentrated force transmission (2)

Shaft length 50 cm	Balloon diameter (mm)	Balloon length (mm)	Sheath compa- tibility (F)	Nominal pressure (atm)	Rated burst pressure (atm)
NW18-05040040	4	40	5 F	8	18
NW18-05050040	5	40	5 F	8	16
NW18-05060040	6	40	6 F	8	16
Shaft length 90 cm					
NW18-09040040	4	40	5 F	8	18
NW18-09050040	5	40	5 F	8	16
NW18-09060040	6	40	6 F	8	16
NW18-09070040	7	40	6 F	8	14
Shaft length 145 cm					
NW18-14540040	4	40	5 F	8	18
NW18-14550040	5	40	5 F	8	16
NW18-14560040	6	40	6 F	8	16
NW18-14570040	7	40	6 F	8	14

(1) Taguchi I et al. Journal of Cardiology 2014;63:19-23.

(2) Ashida K et al. J Invasive Cardiol. 2013 Oct;25(10):555-64. PMID: 24088433.

(3) Data on file at GOODMAN Co. Ltd.

(4) Please see compliance chart for details.

SeQuent[®] Please OTW

Peripheral Drug Coated Balloon Catheter

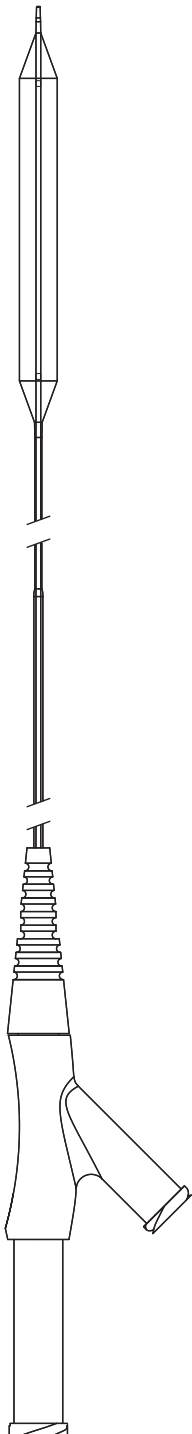

An effective next generation combination of Paclitaxel and Resveratrol (1, 2). It features an optimized and clinically proven drug-coating technology which facilitates the safe and effective treatment of patients with peripheral arterial disease.

Long-term efficacy with short-term drug release (1, 2)

- Paclitaxel with an effective drug dose of $3\mu\text{g}/\text{mm}^2$ (3, 4)
- Significant reduction of TLR and in late lumen loss (LLL) compared to uncoated balloons (1, 2, 5)

Resveratrol: A naturally occurring matrix builder

- Naturally occurring, plant-based substance found for example in the skin of red grapes & raspberries (5)
- Acts as matrix builder and makes the Paclitaxel bioavailable (5)
- Enables fast and effective drug transfer into vessel wall (5)

Mechanically resistant coating (5)

- Homogeneous coating even in the balloon folds exceeding distal and proximal markers (5)
- Low drug loss in simulated use (5)
- Efficient available drug dose at inflation (1, 2, 5)

(1) Albrecht T et al. Cardiovasc Intervent Radiol. 2018 Jul;41(7):1008-14.

(2) Langhoff R et al. Angiology. 2021 Mar 29;3319721997314.

(3) Tepe G et al. N Engl J Med. 2008 Feb 14;358(7):689-99.

(4) Tepe G et al. Cardiovasc Intervent Radiol. 2017 Oct;40(10):1535-44.

(5) Data on file at B. Braun.

SeQuent® Please OTW 014

Peripheral Drug Coated Balloon Catheter

NEW

	Shaft length 75 cm	Shaft length 130 cm	Balloon diameter (mm)	Balloon length (mm)	Sheath compa- tibility (F)	Nominal pressure (atm)	Rated burst pressure (atm)
14215040			1.5	40	4	6	16
14215080			1.5	80	4	6	16
14215120			1.5	120	4	6	16
14220040		14320040	2.0	40	4	6	16
14220080		14320080	2.0	80	4	6	15
14220120		14320120	2.0	120	4	6	15
14220150		14320150	2.0	150	4	6	15
14225040		14325040	2.5	40	4	6	16
14225080		14325080	2.5	80	4	6	15
14225120		14325120	2.5	120	4	6	15
14225150		14325150	2.5	150	4	6	15
14230080			3.0	80	4	6	15
14230120			3.0	120	4	6	15
14230150			3.0	150	4	6	15

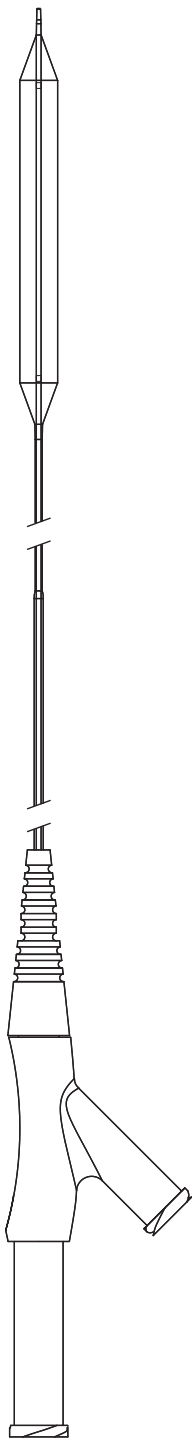

SeQuent® Please OTW 018

Peripheral Drug Coated Balloon Catheter

NEW

	Shaft length 75 cm	Shaft length 130 cm	Balloon diameter (mm)	Balloon length (mm)	Sheath compa- tibility (F)	Nominal pressure (atm)	Rated burst pressure (atm)
		18220040	2.0	40	4	6	16
		18220080	2.0	80	4	6	15
		18220120	2.0	120	4	6	15
		18220150	2.0	150	4	6	15
		18225040	2.5	40	4	6	16
		18225080	2.5	80	4	6	15
		18225120	2.5	120	4	6	15
		18225150	2.5	150	4	6	15
		18230040	3.0	40	4	6	16
		18230080	3.0	80	4	6	15
		18230120	3.0	120	4	6	15
		18230150	3.0	150	4	6	15
	18135040	18235040	3.5	40	4	6	16
	18135080	18235080	3.5	80	4	6	15
	18135120	18235120	3.5	120	4	6	15
	18135150*	18235150*	3.5	150	4	6	15
	18140040	18240040	4.0	40	4	6	16
	18140060	18240060	4.0	60	4	6	16
	18140080	18240080	4.0	80	4	6	15
	18140120	18240120	4.0	120	4	6	15
	18140150	18240150	4.0	150	4	6	15
	18150040	18250040	5.0	40	5	6	14
	18150060	18250060	5.0	60	5	6	14
	18150080	18250080	5.0	80	5	6	13
	18150120	18250120	5.0	120	5	6	13
	18150150	18250150	5.0	150	5	6	13
	18160040	18260040	6.0	40	5	6	14
	18160060	18260060	6.0	60	5	6	14
	18160080	18260080	6.0	80	5	6	12
	18160120	18260120	6.0	120	5	6	12
	18160150	18260150	6.0	150	5	6	12
	18170040		7.0	40	5	6	12
	18170060		7.0	60	5	6	12
	18180040		8.0	40	5	6	12
	18180060		8.0	60	5	6	12

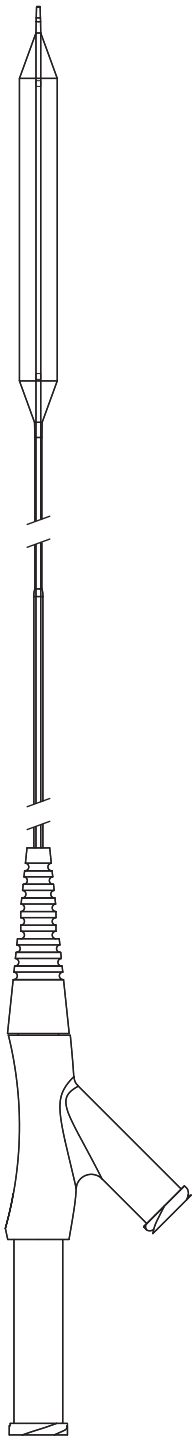

SeQuent® Please OTW 035

Peripheral Drug Coated Balloon Catheter

	Shaft length 75 cm	Shaft length 130 cm	Balloon diameter (mm)	Balloon length (mm)	Sheath compa- tibility (F)	Nominal pressure (atm)	Rated burst pressure (atm)
	35040040	35340040	4.0	40	5	6	16
	35140060	35340060	4.0	60	5	6	16
	35140080	35340080	4.0	80	5	6	15
	35140120	35340120	4.0	120	5	6	15
	35140150	35340150	4.0	150	5	6	15
	35150040	35350040	5.0	40	6	6	14
	35150060	35350060	5.0	60	6	6	14
	35150080	35350080	5.0	80	6	6	13
	35150120	35350120	5.0	120	6	6	13
	35150150	35350150	5.0	150	6	6	13
	35160040	35360040	6.0	40	6	6	13
	35160060	35360060	6.0	60	6	6	13
	35160080	35360080	6.0	80	6	6	12
	35160120	35360120	6.0	120	6	6	12
	35160150	35360150	6.0	150	6	6	12
	35170040		7.0	40	6	6	12
	35170060		7.0	60	6	6	12
	35180040		8.0	40	6	6	12
	35180060		8.0	60	6	6	12

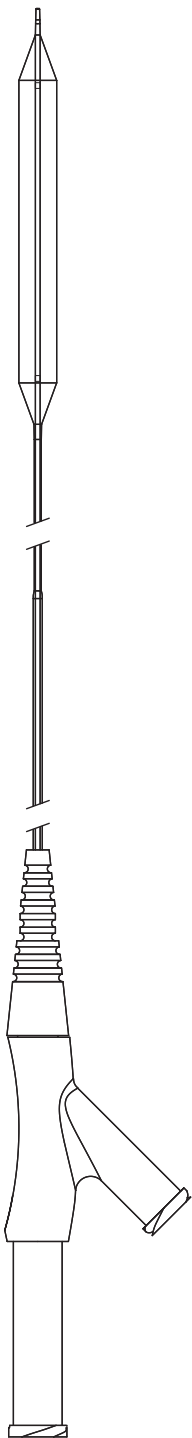

VascuFlex® Multi-LOC

Spot Stenting System



The VascuFlex® LOC portfolio enables the implantation of multiple stents with one delivery system.

The aim of the spot and focal stenting strategies with the VascuFlex® Multiple Stent Systems is to reduce the amount of metal in the vessel. With the VascuFlex® LOC portfolio, all stents can be implanted individually in challenging indications (e.g. recoils, flow-limiting dissections).

VascuFlex® Multi-LOC Spot stenting system:

- 6 F profile device
- 0.035" guidewire compatibility
- 80 and 130 cm shaft lengths
- 5 – 8 mm stent diameter for femoropopliteal lesions
- 13 mm stent length each

Features

- Six freely positionable stents on one delivery system
- Short stents with high radial force (closed cell design) (4)
- Marker acts as retainer to prevent stent jumping (4)

Delivery System	Stent diameter (mm)	Stent length (mm)	Shaft length (cm)	Order number
VascuFlex® Multi-LOC				
6 F	5	6 x 13	130	5506650
6 F	6	6 x 13	130	5506651
6 F	7	6 x 13	130	5506652
6 F	8	6 x 13	130	5506653*
6 F	5	6 x 13	80	5506654
6 F	6	6 x 13	80	5506655
6 F	7	6 x 13	80	5506656
6 F	8	6 x 13	80	5506657*

*available upon request

(1) Amendt K, et al. Vasa (2017), 1–10.doi.org/10.1024/0301-1526/a000658.

(2) Sigl M, Beschorner U, Zeller T, et al. Cardiovasc Intervent Radiol (2018).doi.org/10.1007/s00270-018-2095-9.

(3) Amendt K, et al. Vasa (2020), 1–8.doi.org/10.1024/0301-1526/a000927.

(4) Data on file.

VascuFlex® 2-LOC/3-LOC

Focal Stenting Systems



VascuFlex® 2- and 3-LOC is a focal stenting system with two or three 30 or 40 mm short, freely positionable stents.

VascuFlex® 2- and 3-LOC focal stenting systems:

- 6 F profile device
- 0.035" guidewire compatibility
- 80 and 130 cm shaft lengths
- 5 – 8 mm stent diameter for femoropopliteal lesions
- 30 or 40 mm stent length each

Features

- Implantation of up to 3 stents with one system
- Each stent freely positionable
- Flexible open cell stent design
- Laser welded tantalum markers for good visibility

Delivery System	Stent diameter (mm)	Stent length (mm)	Shaft length (cm)	Order number
-----------------	---------------------	-------------------	-------------------	--------------

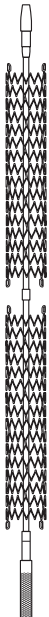

VascuFlex® 2-LOC

6F	5	2 x 30	130	5506600
6F	5	2 x 40	130	5506601
6F	6	2 x 30	130	5506602
6F	6	2 x 40	130	5506603
6F	7	2 x 30	130	5506604
6F	7	2 x 40	130	5506605
6F	8	2 x 30	130	5506606*
6F	8	2 x 40	130	5506607
6F	5	2 x 30	80	5506608
6F	5	2 x 40	80	5506609
6F	6	2 x 30	80	5506610
6F	6	2 x 40	80	5506611
6F	7	2 x 30	80	5506612
6F	7	2 x 40	80	5506613
6F	8	2 x 30	80	5506614*
6F	8	2 x 40	80	5506615

Delivery System	Stent diameter (mm)	Stent length (mm)	Shaft length (cm)	Order number
-----------------	---------------------	-------------------	-------------------	--------------



VascuFlex® 3-LOC

6F	5	3 x 30	130	5506620
6F	5	3 x 40	130	5506621
6F	6	3 x 30	130	5506622
6F	6	3 x 40	130	5506623
6F	7	3 x 30	130	5506624
6F	7	3 x 40	130	5506625
6F	8	3 x 30	130	5506626*
6F	8	3 x 40	130	5506627
6F	5	3 x 30	80	5506628
6F	5	3 x 40	80	5506629
6F	6	3 x 30	80	5506630
6F	6	3 x 40	80	5506631
6F	7	3 x 30	80	5506632
6F	7	3 x 40	80	5506633
6F	8	3 x 30	80	5506634*
6F	8	3 x 40	80	5506635

*available upon request

Angiodyn® Customized Service

Customized Procedure Kits

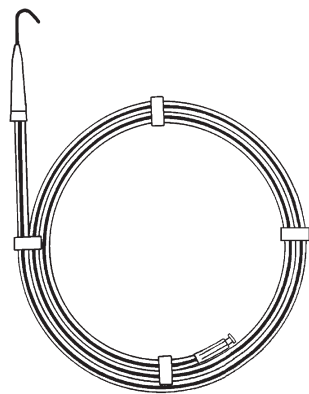

Angiodyn® sterile kits contain an organized array of disposable components for your specific procedure in interventional cardiology, radiology or hemodynamic measurements.

Angiodyn® kits save procedural time since they facilitate patient preparation and postinterventional cleanup as compared to interventions that use individually packaged components. Therefore, the use of your cath lab is further improved by allowing more interventions per day.

Angiodyn® kits are cost effective by simplifying your purchasing and accounting procedures and by consolidating components in one affordable kit.

Benefit from our impressive and wide range of high quality precision components.

Angiodyn®

- Custom made kit solutions
- Precision components
- Quick and easy setup & cleanup
- Simple inventory control
- Convenient storage and delivery
- Increased output (= increased profitability)
- Consistent quality
- Standardized workflow
- Reduced training time for new staff
- Reduced waste volume
- More time with the patient

Are you interested?

Please contact one of our product specialists for further details.

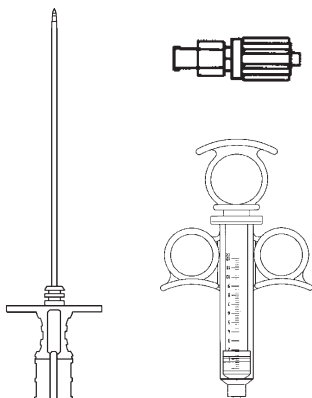
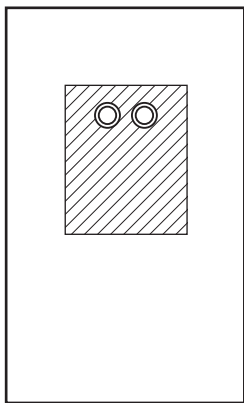

The components in this catalogue are intended for the assembly of customized B. Braun Angiodyn® procedure kits.

Standard Procedure Kits

Standard Kits	Order number
<p>Example for Radiology Basic Kit</p> <hr/> <p>Kit components:</p> <ul style="list-style-type: none"> ▪ Patient cover drape 330 x 211 cm / 2 holes femoral ▪ Cover drape 150 x 180 cm ▪ 2 x Cover drapes 140 x 150 cm ▪ OP tape 10 x 50 cm ▪ Absorbent drape with adhesive tape 90x90 cm ▪ 50 x Gauze compresses 10 x 10 cm, 12-fold ▪ 2 x Angiodyn image intensifier cover 90 x 90 cm ▪ Omnifix® syringe LS, 20 ml ▪ Omnifix® syringe LL, 5 ml ▪ Adhesive tape yellow ▪ 3 x Omnifix® syringes LL, 20 ml ▪ 3 x Omnifix® syringes LL, 10 ml ▪ Needle collector box ▪ Sterican® safety cannula 0,6 x 25 mm, 23 G, blue ▪ Safety scalpel fig.11 ▪ Puncture needle 19G ▪ Guidewire J3 FC-FS 175-035 ▪ High pressure 1-way stopcock, 1050 PSI, blue ▪ High pressure tubing 1200 PSI, 120 cm ▪ Bowl 1000 ml, blue ▪ Bowl 250 ml, transparent ▪ Universal clamp, model Kiel ▪ Cover drape 152 x152, reinforced <hr/> <p>Disinfection kit:</p> <ul style="list-style-type: none"> ▪ SUSI® sponge forceps, straight, 200 mm ▪ Bowl 500 ml, blue ▪ 5 x Swabs, plum size 	<p>5014897</p>

Guidewires, PTFE-coated

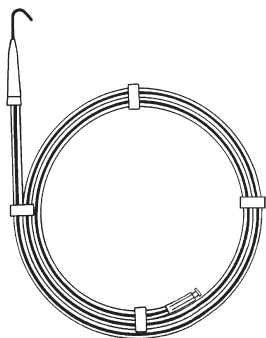

Guidewires for insertion, stabilization and positioning of angiographic catheters.

- PTFE-coated stainless nickel-chromium steel
- Flexible and smooth rounded wire tip
- Sensitive steering and guiding qualities
- Various tip configurations
- Straightener (only for J-tip)
- Standard: With dispenser and luer-lock-fitting for flushing the wire

Product description	Length (cm)	Ø (inch/mm)	Order number	Sales unit (pcs.)
J-tip, fixed core (FC), fingerstraightenable (FS)				
J3 FC-FS 150-035	150	0.035 / 0.89	5050200	10
J3 FC-FS 150-038	150	0.038 / 0.97	5050219	10
J3 FC-FS 175-035	175	0.035 / 0.89	5059755	50
J3 FC-FS 200-035	200	0.035 / 0.89	5050980	50
J3 FC-FS 220-035	220	0.035 / 0.89	5050981	50
J3 FC-FS 260-035	260	0.035 / 0.89	5050359	5
J3 FC-FS 260-038	260	0.038 / 0.97	5050367	5
Straight tip (S), fixed core (FC)				
SFC 150-018	150	0.018 / 0.46	5050456	10
SFC 150-035	150	0.035 / 0.89	5050243	10
SFC 260-038	260	0.038 / 0.97	5050430	5
J-tip, movable core (M), fingerstraightenable (FS)				
MC-FS 150-032	150	0.032 / 0.81	5056470	10
J3 MC-FS 150-035	150	0.035 / 0.89	5050235	10
J3 MC-FS 200-035	200	0.035 / 0.89	5050308	10
J-tip and straight tip (S) (flexible on both ends) fixed core (FC), fingerstraightenable (FS)				
J3 SFC-FS 150-035	150	0.035/0.89	5050227	10
J3 SFC-FS 175-035	175	0.035/0.89	5059208	50
J3 SFC-FS 220-035	220	0.035/0.89	5050360	5

Angiographic Syringes

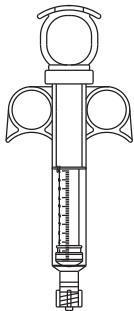

Angiographic syringes for contrast media injection

- Rubber gasket for smooth plunger media injection
- Crystal clear barrel

10 ml angiographic syringe with rotating adapter

- Ring plunger and medium sized grip plate
- Security stop at 1.0 ml
- Lateral finger rings

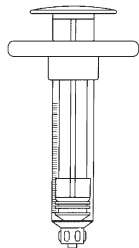

10 ml angiographic syringe with male luer-lock-fitting

- Medium sized grip plate
- Security stop at 1.0 ml

10 ml Angiographic syringe with male luer-lock-fitting

Order number

Sales unit
(pcs.)

5010142

50

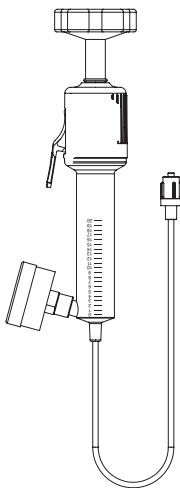

Inflation Device for PTA

Pressure gauge:

- 90° rotating manometer for „custom“ handling
- Coded figures from nominal to burst pressures for easy reading

Body and button:

- Advanced mechanism for rapid pressure increase, i.e. effective and fast procedure
- Grip design for better handling
- Clear material for easy air bubble detection and removal

Handle:

- Ergonomic design for good handling
- Progressive resistance while inflating for pressure feedback

Inflation Device for PTA, 20 ml/30 atm

5028901

1

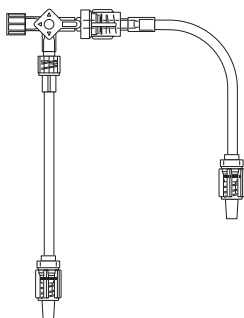

Unique Kissing BiBalloon adaptor

For simultaneous and/or sequential dilatation of bifurcation lesions

- innovative approach for multiple dilatation techniques
- final kissing balloon inflation

Kissing BiBalloon adaptor

5014760

25

Image Intensifier Covers and Bags

Angiodyn® Image intensifier covers and bags

- Protect your equipment from contamination and dust
- PE transparent cover
- With elastic or string fixation

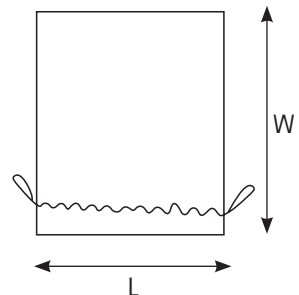
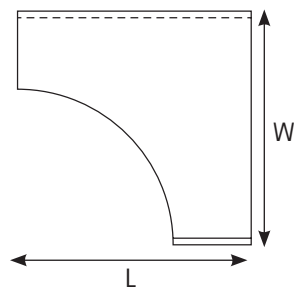
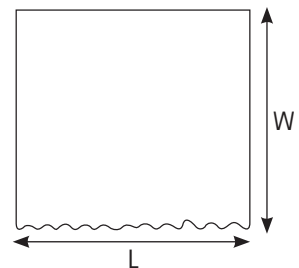
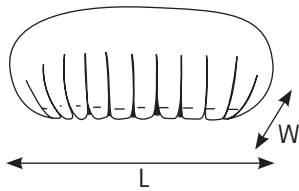

Length = L (cm)	Width = W (cm)	Order number	Sales unit (pcs.)
Angiodyn® Image intensifier cover with elastic fixation			
35	70	5014022	25
45	45	5016733	25
75	80	5010438	25
75	100	5010446	25
80	120	5213568	25
90	90	5017582	25
110	110	5015649	25
120	120	5010085	25
140	140	5018912	25
Angiodyn® Image intensifier bag with elastic fixation			
80	45	5015210	25
80	100	5019520	25
85	90	5019900	25
90	60	5010210	25
90	100	5012629	25
100	100	5014983	25
110	130	5015640	25
Angiodyn® Image intensifier bag (nose type)			
80	80	5018100	50
82	95	5019430	50
117	90	5011179	50
Angiodyn® Bag with string fixation			
60	65	5017745	25
Angiodyn® Lamp handle cover (without illustration)			
		5016255	100
Angiodyn® Table plastic cover (without illustration), blue			
60	65	5012606	25

Notes

A series of horizontal dotted lines for writing notes.

Notes

A series of horizontal dotted lines for writing notes.

B. Braun Melsungen AG | Interventional Vascular Therapy | Sieversufer 8 | 12359 Berlin | Germany | www.bbraun.com

Manufacturer acc. to MDD 93/42EG:

SeQuent® Please OTW, VascuFlex®: B. Braun Melsungen AG, Carl-Braun-Str. 1, 34212 Melsungen, Germany

NSE PTA™: Goodman Co., Ltd. (a subsidiary of NIPRO Corporation)

The product trademarks 'SeQuent', 'VascuFlex', 'Omnifix', 'Discofix', 'Splittocan', 'Introcant' and 'Angiodyn' are registered trademarks of B. Braun Melsungen AG. The product trademark 'SUSI' is a registered trademark of Aesculap AG.

The product trademark 'NSE PTA' is a trademark of Goodman Co., Ltd..

Subject to technical changes. All rights reserved. This brochure may only be used for the exclusive purpose of obtaining information about our products. Reproduction in any form partial or otherwise is not permitted.