

Aesculap Neurosurgery

DUALSWITCH® VALVE

MONOSTEP® VALVE

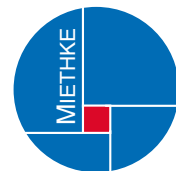

Shunt systems for hydrocephalus treatment

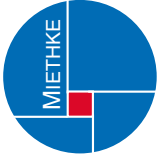

DUALSWITCH[®] VALVE
MONOSTEP[®] VALVE



Alliance for innovation

When two strong partners combine their know-how, this often leads to innovative and groundbreaking solutions, which could not be achieved independently by any of the partners.

Following this philosophy, Aesculap and Miethke have been cooperating since 1999. Our aim was and still is to develop and make available worldwide better solutions for the complex treatment of hydrocephalus.

This vision inspired and motivated everybody in our cooperation. It started with an intensive exchange with customers, doctors and patients about the difficult issues involved in hydrocephalus therapy. New solutions were conceived and discussed in small circles of experts and at scientific meetings.

This process finally resulted in the market launch of the first gravitational system, which effectively prevents overdrainage of cerebrospinal fluid (CSF). – a world first and milestone in modern hydrocephalus therapy.

So we already achieved a lot, but this is only the beginning. We are determined to continue on the route we embarked on. For the good of the patient, we will continue with our considerable investments in research and development and will not tire to learn more, create further expertise and remain open for future developments.



Aesculap, Tuttlingen



Miethke, Potsdam

*We will continue to venture in new directions
and cross every frontier to provide help for cases where
a solution has not been found yet.*



DUALSWITCH® VALVE

MONOSTEP® VALVE

DUALSWITCH® VALVE
MONOSTEP® VALVE
the valve

When treated with a shunt system, patients with posthemorrhage hydrocephalus are faced with the risk of valve blockages due to blood-loaded cerebrospinal fluid. A high protein level or tumor cells in the CSF, too, can lead to such problems. These issues were given particular consideration in the development of the *DUALSWITCH® VALVE* and *MONOSTEP® VALVE*. The parallel valve chambers present a very large surface area to the CSF, thus ensuring reliable operation even with contaminated fluid.

As is evident from the equation

$$P=F/A \quad (P=\text{pressure, } F=\text{force, } A=\text{area}),$$

a large area also allows a stronger force. This force is provided by a relatively stiff spring, making the valve mechanism effectively immune against any effects caused by proteins, blood or tumor cells.

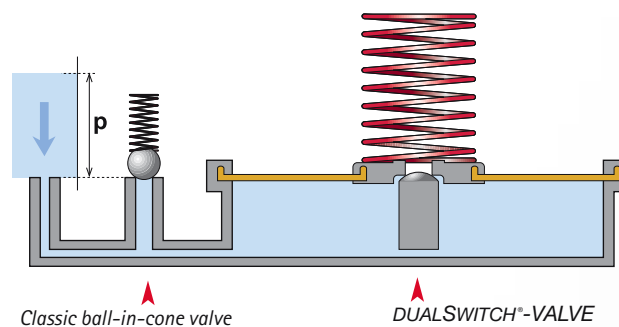

With the *DUALSWITCH® VALVE* and the *MONOSTEP® VALVE* we offer you two "special solutions", which catch the eye not least because of their particular shell design.

For many years now, the *DUALSWITCH*[®] *VALVE* is also used very successfully in the treatment of NPH. Numerous publications offer evidence for its effectiveness for that indication. In a similar way as in our *GAV*[®] valve, a special gravitational mechanism in the *DUALSWITCH*[®] *VALVE* prevents shunt overdrainage.

“After 6 years of experience with the DSV, we arrived at a clearly positive assessment of the reliability of the design principle of this gravity-assisted hydrostatic valve. ...

*Because of the low incidence of over and under-drainage and the good postoperative results, we recommend implanting DSV as ventriculo-peritoneal shunts for patients with iNPH.”**

*U. Meier, Department of Neurosurgery, clinic for accident cases Berlin, Berlin, Germany
"Gravity valves for idiopathic normal-pressure hydrocephalus: a prospective study with 60 patients"
Acta Neurochir (2005) [Suppl] 95:201-205





DUALSWITCH® VALVE MONOSTEP® VALVE

DUALSWITCH® VALVE
the valve

*“The gravitational ball valves...showed the closest
relation to physiological flow requirements.”**

*Oikonomou J., Aschoff A., Hashemi B., Kunze S., New valves – new dangers? 22 valves designed in the nineties in ultralong-term tests (365 days). Eur J Pediatr Surg 1999; 9 Suppl 1:23-6

- Valve system with parallel chambers and integrated gravity unit
- Physiological CSF drainage through active adaptation of the opening pressure to the patient's physical position
- Effective protection against CSF overdrainage, thus prevention of slit ventricle syndrome
- Reduced risk of blockage thanks to maximized flow volume and very robust yoke springs

DUALSWITCH®-VALVE





Our recommendation:**

Patient's height	Standard valve	NPH valve
up to 160 cm	10 / 30 cmH ₂ O	5 / 30 cmH ₂ O
160 - 180 cm	10 / 40 cmH ₂ O	5 / 40 cmH ₂ O
above 180 cm	10 / 50 cmH ₂ O	5 / 50 cmH ₂ O

** These guide values are not binding. Other specifications may be preferable for the individual patient and anamnesis.

- We recommend implanting the *DUALSWITCH*[®] VALVE in the thoracic region. The implantation height of the implant does not affect its functionality in any way.

Your choice:

The *DUALSWITCH*[®] VALVE is available with various pressure levels. Each pressure level is identified by a special marker code, which can be read through postoperative radiography.

Opening pressure horizontal/vertical (cmH ₂ O)	<i>DUALSWITCH</i> [®] -VALVE X-ray marker code	Opening pressure horizontal/vertical (cmH ₂ O)	<i>DUALSWITCH</i> [®] -VALVE X-ray marker code
5 / 30		10 / 50	
5 / 40		13 / 30	
5 / 50		13 / 40	
10 / 30		13 / 50	
10 / 40			

DUALSWITCH[®] VALVE

*Our recommendation
Your choice*



DUALSWITCH® VALVE MONOSTEP® VALVE

DUALSWITCH® VALVE

The Functions

Supine Function

Precise and safe functioning of the *DUALSWITCH® VALVE* is ensured by implanting the valve parallel to the body axis.

- When the patient is supine, the *DUALSWITCH® VALVE* is in a horizontal position.
- The low-pressure level valve chamber keeps the patient's intraventricular pressure within physiological limits.
- The ball of the gravity unit can move freely and does not present an additional flow resistance while the patient is lying down, because the flow channel at this point is kept open automatically.

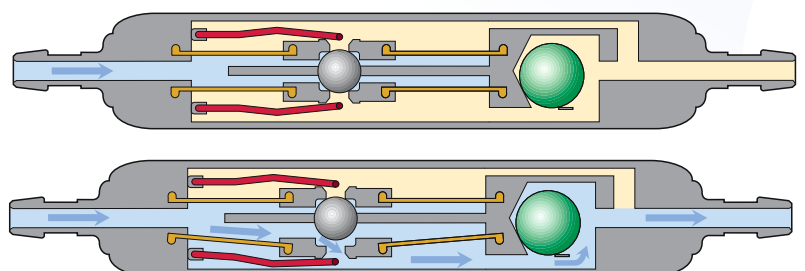
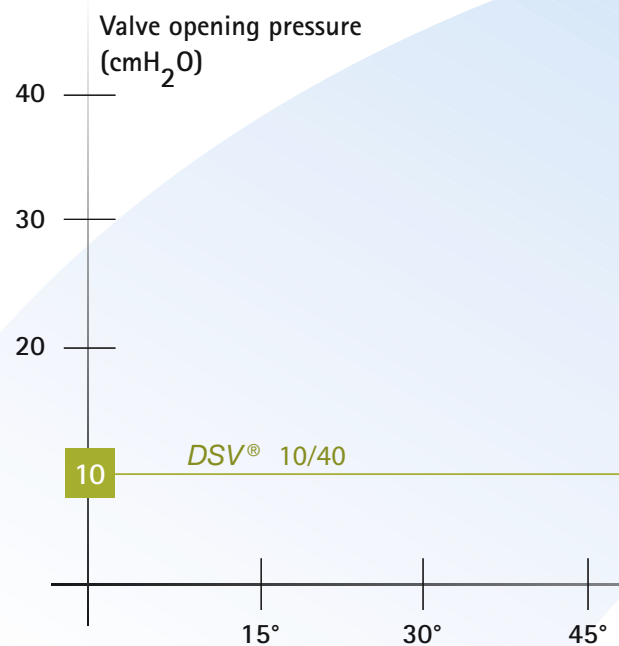
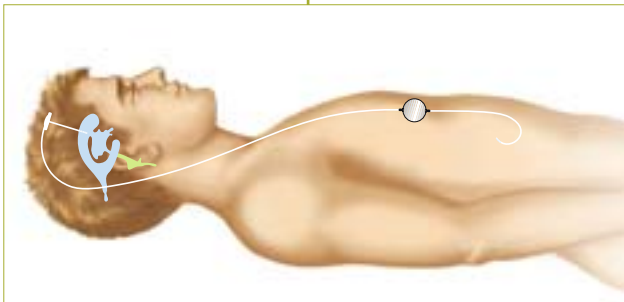

DUALSWITCH® VALVE
The Functions

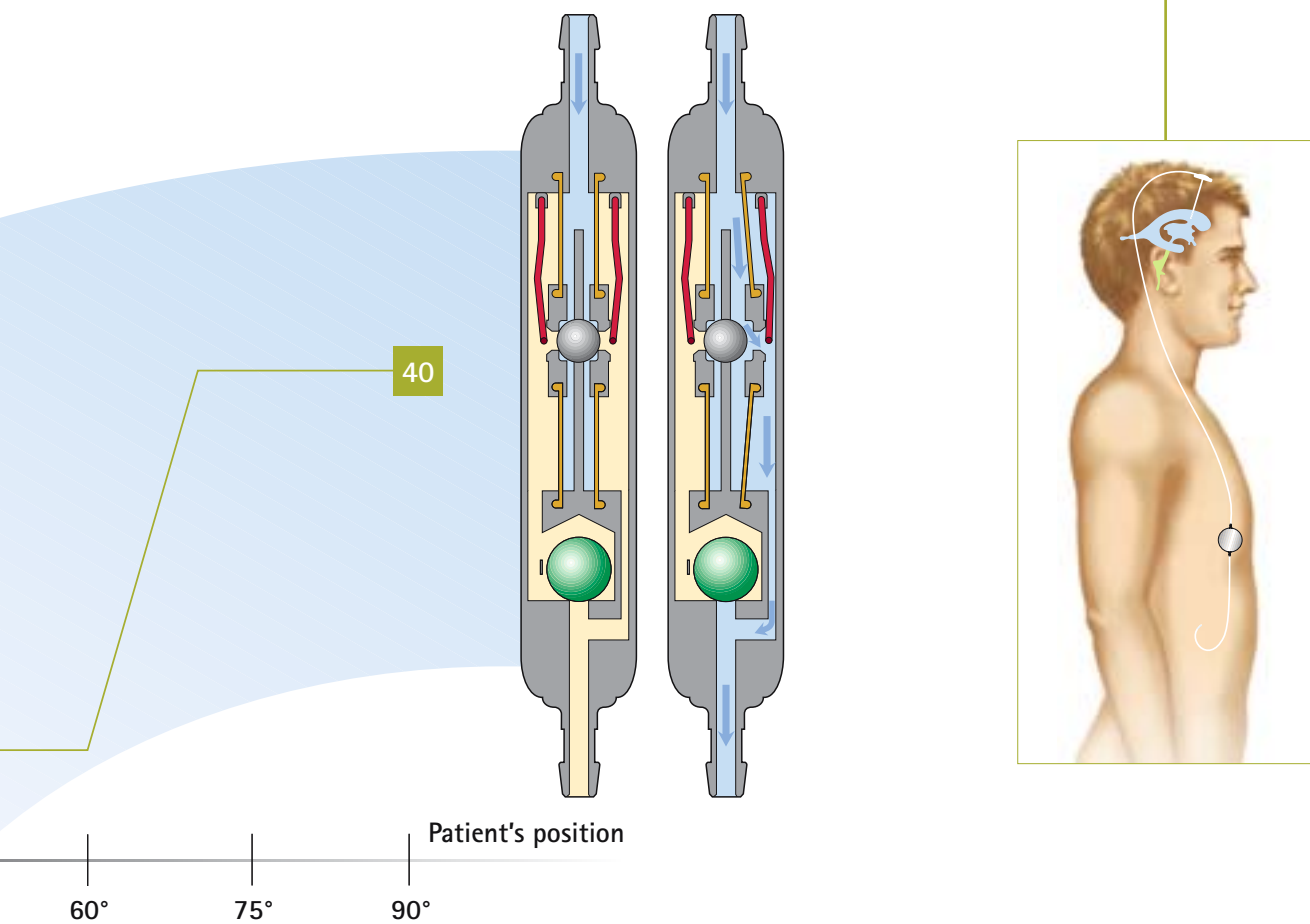

Upright Function

The gravity unit is activated whenever the patient moves to an upright position.

- From a body angle of approx. 60°, the valve automatically switches to activation of the higher-pressure valve chamber.
- This higher valve opening pressure in the upright position effectively prevents overdrainage and ensures that a physiological brain pressure is maintained in this position too.



DUALSWITCH® VALVE MONOSTEP® VALVE

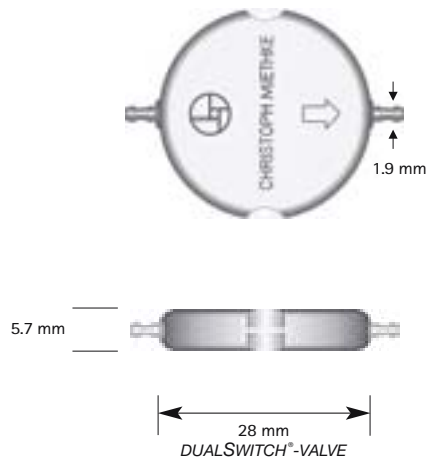

DUALSWITCH® VALVE

Single valve with two connections



Scale 1:1

Valve pressure level (cmH₂O*)

Art. no.	Valve pressure level (cmH ₂ O*)	
		
FV190T	5	30
FV191T	5	40
FV192T	5	50
FV100T	up to 160 cm**	10
FV101T	160 - 180 cm**	10
FV102T	above 180 cm**	10
FV103T	13	30
FV104T	13	40
FV105T	13	50

**Standard pressure levels. These guide values are not binding. Other specifications may be preferable for the individual patient and anamnesis.

* 1 cmH₂O = 0.74 mmHg



DUALSWITCH® VALVE with distal catheter

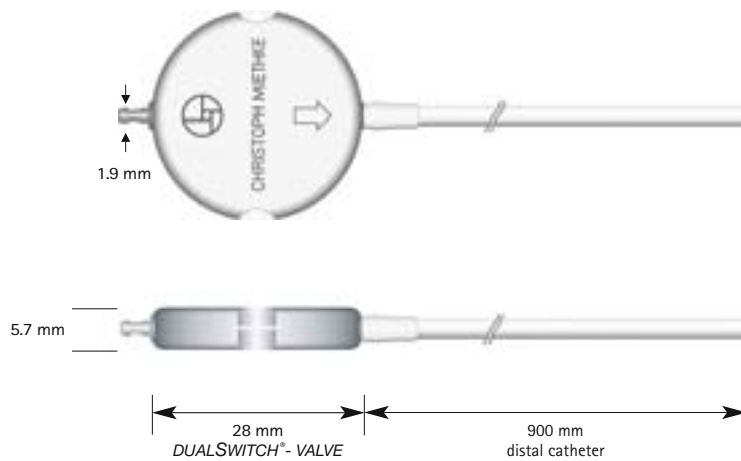



Single valve with
preattached distal
catheter

all catheters: $d_i = 1.2 \text{ mm}$, $d_o = 2.5 \text{ mm}$

Scale 1:1

Valve pressure level (cmH₂O*)

Art. no.	Valve pressure level (cmH ₂ O*)	
		
FV370T	5	30
FV371T	5	40
FV372T	5	50
FV118T	up to 160 cm**	10
FV119T	160 – 180 cm**	10
FV120T	above 180 cm**	10
FV121T	13	30
FV122T	13	40
FV123T	13	50

**Standard pressure levels. These guide values are not binding. Other specifications may be preferable for the individual patient and anamnesis.

* 1 cmH₂O = 0.74 mmHg



DUALSWITCH® VALVE MONOSTEP® VALVE

DUALSWITCH® SHUNT SYSTEM with FLUSHING RESERVOIR

Valve system with two connections

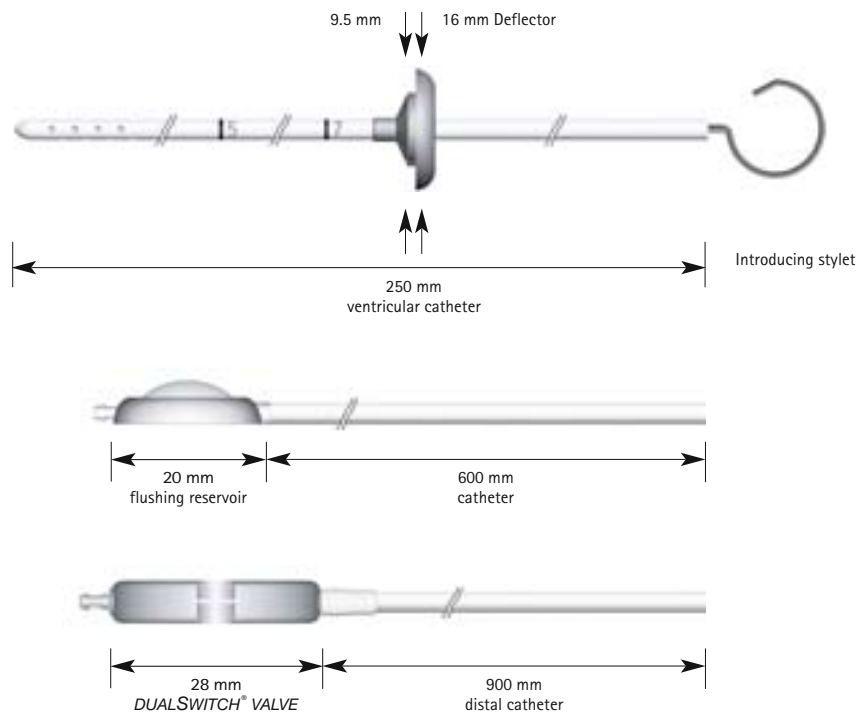

- Ventricular catheter with introducing stylet and deflector
- Flushing reservoir with integrated catheter
- Valve with integrated distal catheter

all catheters: $d_i = 1.2 \text{ mm}$, $d_o = 2.5 \text{ mm}$



Scale 1:1

Valve pressure level (cmH₂O*)

Art. no.	Valve pressure level (cmH ₂ O*)	
		
FV379T	5	30
FV380T	5	40
FV381T	5	50
FV172T	up to 160 cm**	10
FV173T	160 - 180 cm**	10
FV174T	above 180 cm**	10
FV175T	13	30
FV176T	13	40
FV177T	13	50

**Standard pressure levels. These guide values are not binding. Other specifications may be preferable for the individual patient and anamnesis.

* 1 cmH₂O = 0.74 mmHg



DUALSWITCH® SHUNT SYSTEM with BURRHOLE RESERVOIR

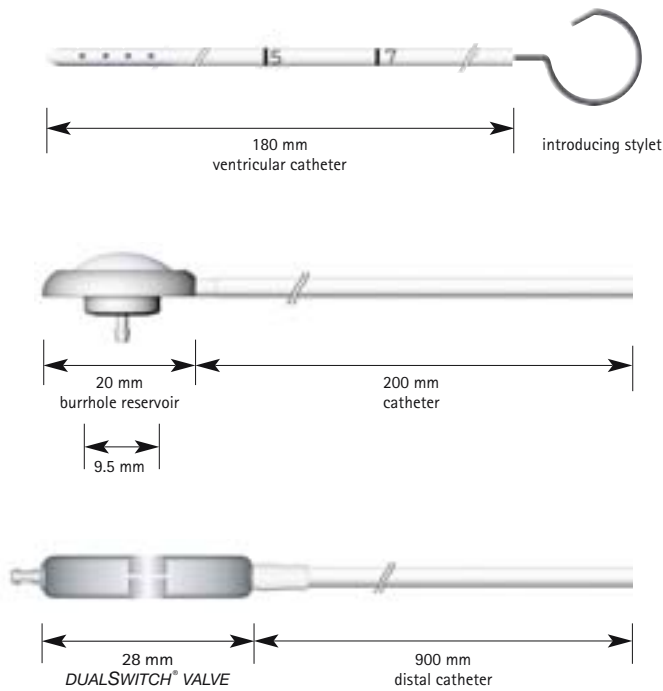

Scale 1:1



Valve system with two connections

- Ventricular catheter with mandrel
- Burrhole reservoir with integrated catheter
- Valve with integrated distal catheter

all catheters: $d_i = 1.2 \text{ mm}$, $d_o = 2.5 \text{ mm}$

DUALSWITCH® VALVE

Valve pressure level (cmH₂O*)

Art. no.	Valve pressure level (cmH ₂ O*)	
		
FV376T	5	30
FV377T	5	40
FV378T	5	50
FV145T	up to 160 cm**	10
FV146T	160 – 180 cm**	10
FV147T	above 180 cm**	10
FV148T	13	30
FV149T	13	40
FV150T	13	50

**Standard pressure levels. These guide values are not binding. Other specifications may be preferable for the individual patient and anamnesis.

* 1 cmH₂O = 0.74 mmHg



DUALSWITCH® VALVE MONOSTEP® VALVE

DUALSWITCH® SHUNT SYSTEM with SPRUNG RESERVOIR*

Valve system with two connections

- Ventricular catheter with introducing stylet
- Burrhole reservoir with integrated catheter; design acc. to Dr. Sprung
- Valve with integrated catheter

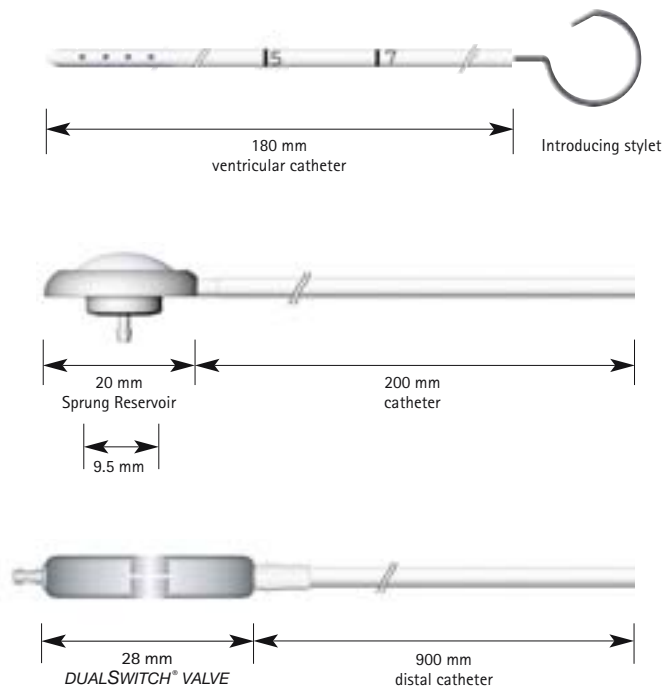

* Flushable reservoir for control of the ventricular catheter's patency and the distal share of drainage

all catheters: $d_i = 1.2 \text{ mm}$, $d_o = 2.5 \text{ mm}$



Scale 1:1

Valve pressure level (cmH₂O*)

Art. no.	Valve pressure level (cmH ₂ O*)	
		
FV385T	5	30
FV386T	5	40
FV387T	5	50
FV388T	up to 160 cm**	30
FV389T	160 - 180 cm**	40
FV390T	above 180 cm**	50

**Standard pressure levels. These guide values are not binding. Other specifications may be preferable for the individual patient and anamnesis.

* 1 cmH₂O = 0.74 mmHg



DUALSWITCH® VALVE for L-P drainage

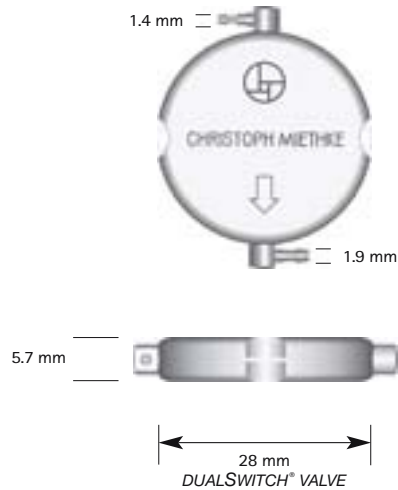



Single valve with two connections

- for lumbo-peritoneal drainage

all catheters: $d_i = 1.2 \text{ mm}$, $d_o = 2.5 \text{ mm}$

Scale 1:1

Valve pressure level (cmH₂O*)

Art. no.	Valve pressure level (cmH ₂ O*)	
		
FV373T	5	30
FV374T	5	40
FV375T	5	50
FV127T	up to 160 cm**	30
FV128T	160 – 180 cm**	40
FV129T	above 180 cm**	50
FV130T	13	30
FV131T	13	40
FV132T	13	50

**Standard pressure levels. These guide values are not binding. Other specifications may be preferable for the individual patient and anamnesis.

* 1 cmH₂O = 0.74 mmHg



DUALSWITCH® VALVE MONOSTEP® VALVE

DUALSWITCH® SHUNT SYSTEM for L-P drainage

Valve system with one connection

- Valve only, with integrated flushing reservoir and integrated distal catheter
- for lumbo-peritoneal drainage

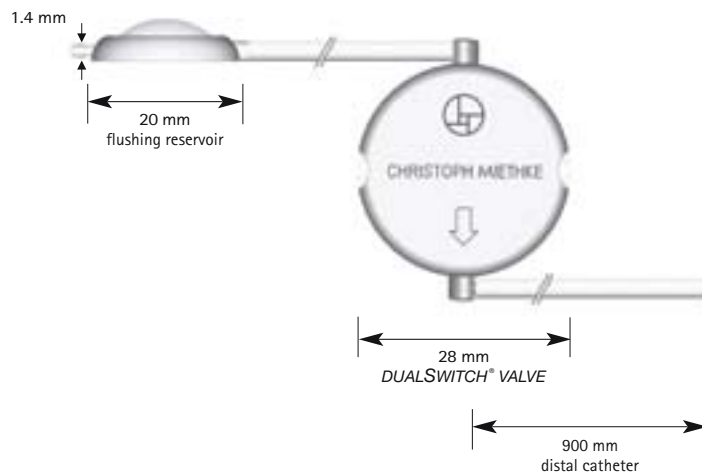

all catheters: $d_i = 1.2 \text{ mm}$, $d_o = 2.5 \text{ mm}$

Scale 1:1

Valve pressure level (cmH₂O*)

Art. no.	Valve pressure level (cmH ₂ O*)	
FV382T	5	30
FV383T	5	40
FV384T	5	50
FV163T	up to 160 cm**	10
FV164T	160 - 180 cm**	10
FV165T	above 180 cm**	10
FV166T	13	30
FV167T	13	40
FV168T	13	50

**Standard pressure levels. These guide values are not binding. Other specifications may be preferable for the individual patient and anamnesis.

* 1 cmH₂O = 0.74 mmHg



proGAV[®] – the adjustable MIETHKE gravitational valve

3 Tesla
MRI safe



Aesculap Neurosurgery

- Adjustable ball-in-cone valve, 0–200 mmH₂O
- Integrated "SHUNTASSISTANT[®]" for effective protection against overdrainage
- "Active-Lock" mechanism to prevent unintended readjustment in MRI fields up to 3 Tesla
- Set pressure level can be read without use of X-ray imaging
- Handy instruments for easy readjustment and reading of the pressure level
- High-precision titanium valve technology



DUALSWITCH® VALVE

MONOSTEP® VALVE

MONOSTEP® VALVE

The valve
Your choice

In contrast to the *DUALSWITCH® VALVE*, the *MONOSTEP® VALVE* has only one valve chamber and no gravity unit, so that it operates as a standard differential pressure valve. Its unique configuration with a relatively large flow volume and a robust yoke spring ensure reliable operation.

MONOSTEP® VALVE



Your choice:

The *MONOSTEP® VALVE* is available with various pressure levels. Each pressure level is identified by a special marker code, which can be read through postoperative radiography.

Opening pressure horizontal (cmH ₂ O)	MONOSTEP® VALVE X-ray marker code
5	
7	
10	
13	
16	



Our recommendation:**

Patient's height	Standard valve
any height	10 cmH ₂ O

** These guide values are not binding. Other specifications may be preferable for the individual patient and anamnesis.

MONOSTEP® VALVE
Our recommendation
Mode of operation

Horizontal mode

- The *MONOSTEP® VALVE* is particularly suitable for passive, recumbent patients.
- For active patients who will stand up or sit, we recommend combining this valve with a *SHUNT-ASSISTANT®* or *PAEDI-SHUNTASSISTANT®*, respectively.

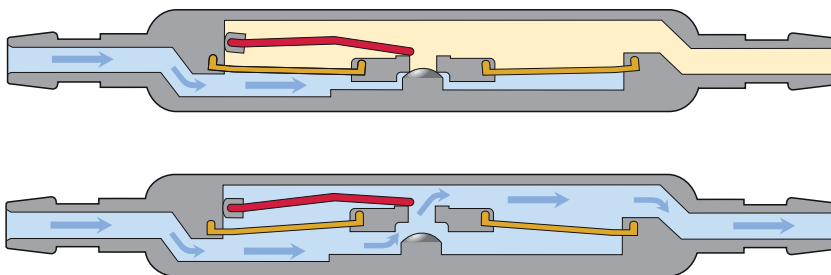
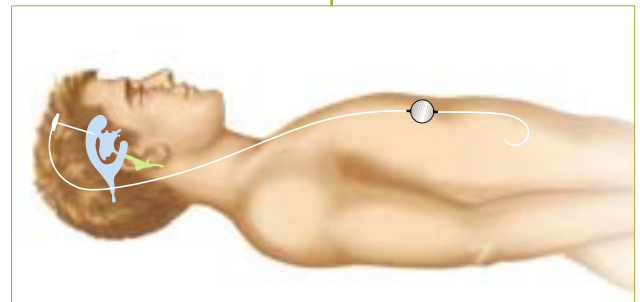



DUALSWITCH® VALVE

MONOSTEP® VALVE

MONOSTEP® VALVE

Single valve with two connections

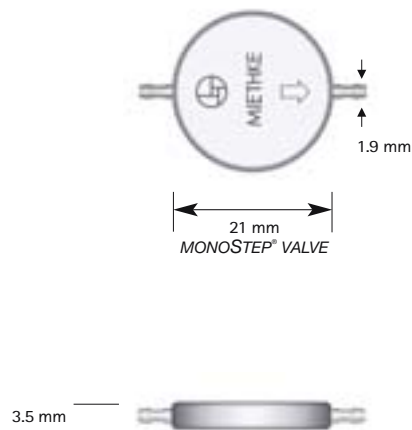

Scale 1:1

Art. no.	Valve pressure level (cmH ₂ O*)
	
FV200T	5
FV201T	7
FV202T**	10
FV203T	13
FV204T	16

**Standard pressure level. *This guide value is not binding. Other specifications may be preferable for the individual patient and anamnesis.*

* 1 cmH₂O = 0.74 mmHg



MONOSTEP® SHUNT SYSTEM with BURRHOLE RESERVOIR

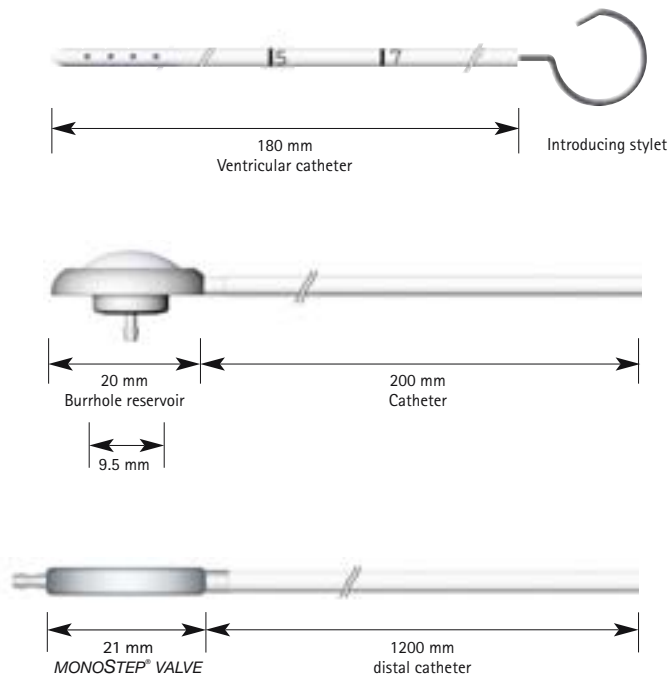

Scale 1:1

Valve system with two connections

- Ventricular catheter with introducing stylet
- Burrhole reservoir with integrated catheter
- Valve with integrated distal catheter

all catheters: $d_i = 1.2 \text{ mm}$, $d_a = 2.5 \text{ mm}$

Art. no.	Valve pressure level (cmH ₂ O*)	
FV210T	5	
FV211T	7	
FV212T**	10	
FV213T	13	
FV214T	16	

**Standard pressure level. This guide value is not binding. Other specifications may be preferable for the individual patient and anamnesis.

* 1 cmH₂O = 0.74 mmHg



DUALSWITCH® VALVE MONOSTEP® VALVE

MONOSTEP® SHUNT SYSTEM with FLUSHING RESERVOIR

Valve system with one connection

- Ventricular catheter with introducing stylet and deflector
- Valve with integrated flushing reservoir and integrated distal catheter

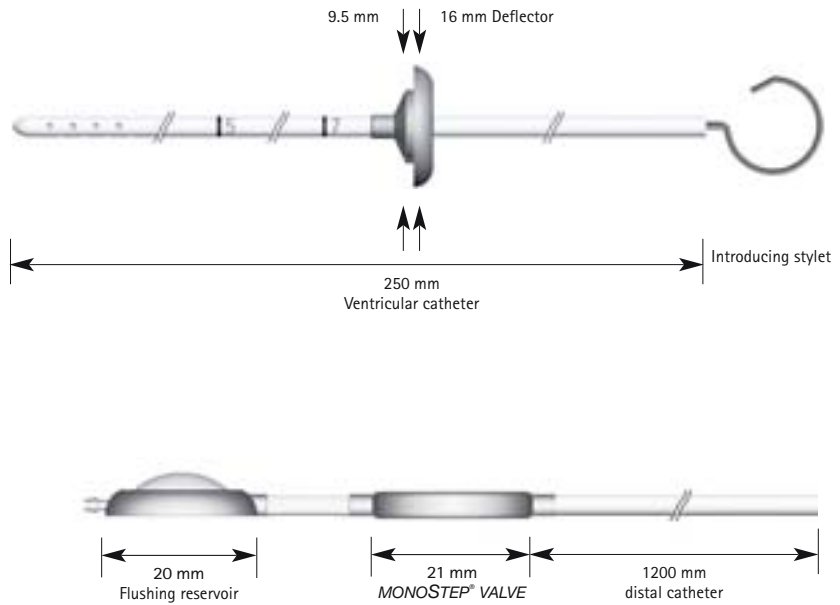

all catheters: $d_i = 1.2 \text{ mm}$, $d_a = 2.5 \text{ mm}$

Scale 1:1

Art. no.	Valve pressure level (cmH ₂ O*)
FV220T	5
FV221T	7
FV222T**	10
FV223T	13
FV224T	16

**Standard pressure level. This guide value is not binding. Other specifications may be preferable for the individual patient and anamnesis.

* 1 cmH₂O = 0.74 mmHg





AESCULAP®

Manufacturer acc. MDD 93/42/EEC

CHRISTOPH MIETHKE GMBH & CO. KG

Ulanenweg 2
14469 Potsdam/Germany
Phone +49 331 62 083-0
+49 7000 MIETHKE
Fax +49 331 62 083-40
www.miethke.com

B | BRAUN
SHARING EXPERTISE

Aesculap AG & Co. KG

Am Aesculap-Platz
78532 Tuttlingen
Germany

Phone +49 7461 95-0
Fax +49 7461 95-2600
www.aesculap.de

All rights reserved. Technical alterations are possible. This leaflet may be used for no other purposes than offering, buying and selling of our products. No part may be copied or reproduced in any form. In the case of misuse we retain the rights to recall our catalogues and pricelists and to take legal actions.