



Interventional Vascular Diagnostics and Therapy

Cardiology

Your Partner for
Coronary Angioplasty

B. Braun Vascular Systems

The European Alternative for Competent Services and High Quality Products

B. Braun SE is one of the world's leading providers and manufacturers of healthcare solutions with a tradition going back more than 180 years.

The company offers products and services for vascular interventions, anesthesiology, intensive care medicine, infusion therapy, surgery and medical engineering. By offering supplementary services and consulting, B. Braun serves hospitals and doctors as a system partner.

Through constructive dialogues with partners and customers, more than 66,000 B. Braun employees are dedicated to developing effective solutions and contributing to medical advancement worldwide.

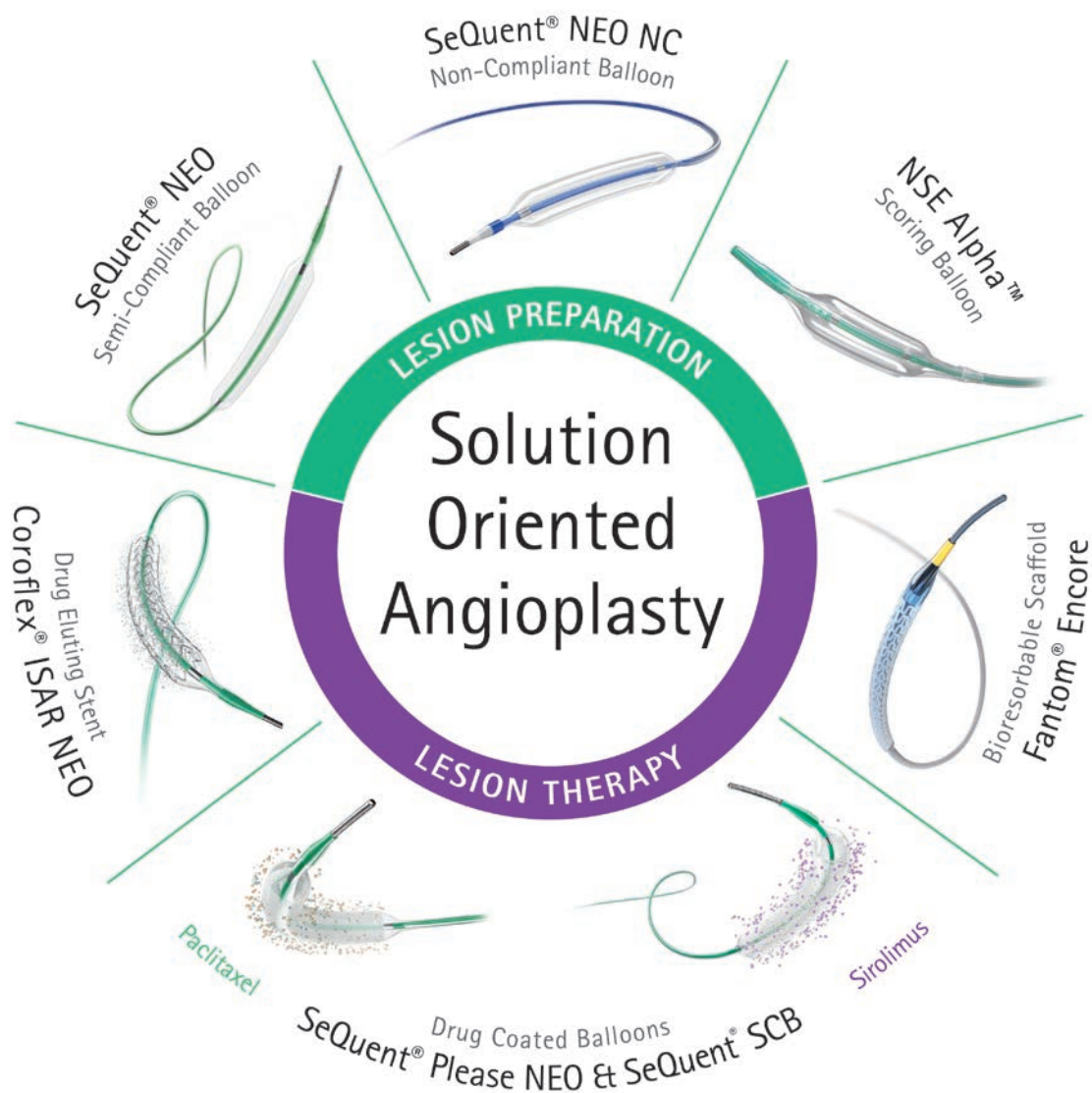

Vascular Systems

Products for Cardiology

Drug Eluting Stent System

4 Coroflex® ISAR NEO

Bioresorbable Scaffold

5 Fantom® Encore

Drug Coated Balloon Catheter

6 SeQuent® Please NEO

7 SeQuent® SCB

PTCA Balloon Catheter

8 SeQuent® NEO

9 SeQuent® NEO NC

Scoring Balloon Catheter

10 NSE Alpha™

Coronary Guiding Catheter

11 Serpia®

Accessories for PTCA

12 Metal Insertion Tool

12 Torquer

12 Y-Connector

12 Unique Kissing BiBalloon Adaptor

13 Inflation Device for PTCA

13 Fluid Collection System

14 PTCA Kits

14 Bifurcation Kit

Angiographic Catheter

15 - 17 Diagnostic Catheters for Angiography

Angiodyn Procedure Kits and Service

18 Standard Kits

19 Basic Set

Angiographic Accessories

20 Angiodyn® Guide Wires

21 - 22 Angiodyn® High Pressure Full-Body
Manifolds

23 Angiodyn® High Pressure Tubing

24 Angiodyn® Syringes

24 Angiodyn® Contrast Saver System

24 Angiodyn® Contrast Saver Tubing

25 Angiodyn® Angiographic Syringes

25 Angiodyn® Injector Syringes

26 - 27 Angiodyn® Image Intensifier Covers
and Bags

Catheter Introducer Sheath

28 Intradyn® Arterial

Introducer Sheath (Seldinger Technique)

29 Intradyn® Tear-Away

30 Conversion Table

Coroflex® ISAR NEO

Next Generation Drug Eluting Stent

Technical Data



Stent material	Cobalt-chromium alloy L605
Stent strut thickness	55 µm (0.0022") for stents 2.0 – 3.0 mm 65 µm (0.0026") for stents 3.5 – 4.0 mm
Matrix coating technology	50:50 ratio (Sirolimus/ ProbucoI)
Drug load on stent	1.2 µg/mm ²
Proximal shaft	1.9 F
Distal shaft	2.5 F
Usable length	145 cm
Guide wire compatibility	5 F (standard guiding catheter) 6 F (Kissing compatibility)
Lesion entry profile	0.016" (0.41 mm)
Crossing profile	0.031" - 0.038"
Nominal pressure (NP)	10 atm
Rated Burst Pressure (RBP)	18 atm (Ø 2.00 - 3.5 mm) 15 atm (Ø 4.0 mm)

Stent Diameter (mm)	Stent Length (mm)							
	9	12	16	19	24	28	32	38
2.0	5028910	5028917	5028924	5028931	5028938	5028945	5028952	5028959
2.25	5028911	5028918	5028925	5028932	5028939	5028946	5028953	5028960
2.5	5028912	5028919	5028926	5028933	5028940	5028947	5028954	5028961
2.75	5028913	5028920	5028927	5028934	5028941	5028948	5028955	5028962
3.0	5028914	5028921	5028928	5028935	5028942	5028949	5028956	5028963
3.5	5028915	5028922	5028929	5028936	5028943	5028950	5028957	5028964
4.0	5028916	5028923	5028930	5028937	5028944	5028951	5028958	5028965
Sales Unit (pcs.)	1							

Material codes for Coroflex® ISAR NEO products might differ slightly in your country. Please contact one of our product specialists for more information.

Fantom[®] Encore

Sirolimus-Eluting Bioresorbable Coronary Scaffold

Technical Data



Coating technology	Tyrocore [®] + Sirolimus
Drug dose	1.97 µg/mm ²
Proximal shaft	2.1 F (0.69 mm)
Distal shaft	2.8 F (0.94 mm)
Usable length	139 cm
Crossing profile	0.051" (1.3 mm)
Lesion entry profile	0.019" (0.5 mm)
Scaffold-strut thickness	Ø 2.50 mm 95 µm (0.0037") Ø 3.00 mm 105 µm (0.0041") Ø 3.50 mm 115 µm (0.0045") Ø 4.00 mm 125 µm (0.0049")
Guide catheter compatibility	6 F
Guide wire compatibility	0.014" (0.6 mm)
Nominal pressure (NP)	7 atm
Rate Burst Pressure (RBP)	18 atm
Expansion tolerance	0.75 mm above nominal pressure (2.50 mm; 3.00 mm) 0.50 mm above nominal pressure (3.50 mm; 4.0 mm)

Diameter (mm)	Length (mm)				
	12	18	24	36	48
2.50	910025-12	910025-18	910025-24	910025-36	910025-48
3.00	910030-12	910030-18	910030-24	910030-36	910030-48
3.50	910035-12	910035-18	910035-24	910035-36	910035-48
4.00	910040-12	910040-18	910040-24	910040-36	910040-48

Sales Unit 1
(pcs.)

Fantom[®] Encore is available in selected countries only.
Please contact one of our product specialists for more information.

SeQuent[®] Please NEO

Paclitaxel Coated Balloon for PTCA

Technical Data



Delivery system	Rapid Exchange
Proximal shaft	1.9 F
Distal shaft	2.5 F
Usable length	145 cm
Brachial & femoral marker	100 cm & 110 cm
Guiding catheter compatibility	5 F
Guide wire compatibility	0.014"
Tip profile	0.016"
Balloon compliance	Semi-compliant standard balloons
Crossing profile	0.033" - 0.037"
Nominal pressure (NP)	6 atm
Rated Burst Pressure (RBP)	14 atm

Balloon Diameter (mm)	Balloon Length (mm)						
	10	15	20	25	30	35	40
2.0	5023200	5023210	5023220	5023230	5023240	5023250	5023260
2.25	5023201	5023211	5023221	5023231	5023241	5023251	5023261
2.5	5023202	5023212	5023222	5023232	5023242	5023252	5023262
2.75	5023203	5023213	5023223	5023233	5023243	5023253	5023263
3.0	5023204	5023214	5023224	5023234	5023244	5023254	5023264
3.5	5023206	5023216	5023226	5023236	5023246	5023256	5023266
4.0	5023207	5023217	5023227	5023237	5023247	5023257	5023267

Sales Unit (pcs.)	1
-------------------	---

SeQuent[®] SCB

Sirolimus Coated Balloon for PTCA

Technical Data

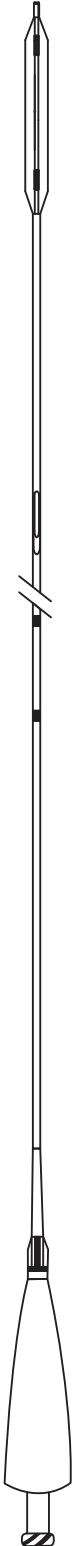

Delivery system	Rapid Exchange
Proximal shaft	1.9 F
Distal shaft	2.5 F
Usable length	145 cm
Brachial & femoral marker	100 cm & 110 cm
Guiding catheter compatibility	5 F
Guide wire compatibility	0.014"
Tip profile	0.016"
Balloon compliance	Semi-compliant standard balloons
Crossing profile	0.033" - 0.037"
Nominal pressure (NP)	6 atm
Rated Burst Pressure (RBP)	14 atm

Balloon Diameter (mm)	Balloon Length (mm)						
	10	15	20	25	30	35	40
2.0	5024250D	5024257D	5024264D	5024271D	5024278D	5024285D	5024292D
2.25	5024251D	5024258D	5024265D	5024272D	5024279D	5024286D	5024293D
2.5	5024252D	5024259D	5024266D	5024273D	5024280D	5024287D	5024294D
2.75	5024253D	5024260D	5024267D	5024274D	5024281D	5024288D	5024295D
3.0	5024254D	5024261D	5024268D	5024275D	5024282D	5024289D	5024296D
3.5	5024255D	5024262D	5024269D	5024276D	5024283D	5024290D	5024297D
4.0	5024256D	5024263D	5024270D	5024277D	5024284D	5024291D	5024298D

Sales Unit (pcs.)	1
-------------------	---

SeQuent[®] NEO

PTCA Balloon Catheter

Technical Data

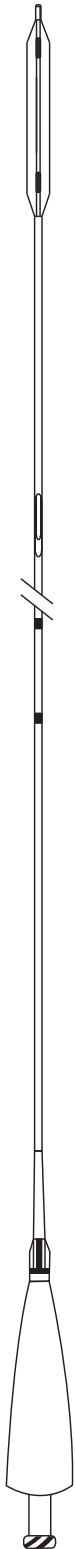

Delivery system	Rapid Exchange
Proximal shaft	1.9 F
Distal shaft	2.5 F
Usable length	145 cm
Brachial & femoral marker	100 cm & 110 cm
Guiding catheter compatibility	5 F / "Kissing" balloon in 6 F
Guide wire compatibility	0.014"
Tip profile	0.016"
Balloon compliance	Semi-compliant standard balloons Non-compliant 1.25 mm & 1.5 mm balloons
Crossing profile	0.023" - 0.026"
Nominal pressure (NP)	6 atm (Ø 1.25 - 1.5: 10 atm)
Rated Burst Pressure (RBP)	14 atm (Ø 1.25 - 1.5: 18 atm)

Balloon Diameter (mm)	Balloon Length (mm)				
	10	15	20	25	30
1.25	5021711D	5021721D	5021731D		
1.5	5021712D	5021722D	5021732D		
2.0	5021713D	5021723D	5021733D	5021743D	5021753D
2.25	5021714D	5021724D	5021734D	5021744D	5021754D
2.5	5021715D	5021725D	5021735D	5021745D	5021755D
2.75	5021716D	5021726D	5021736D	5021746D	5021756D
3.0	5021717D	5021727D	5021737D	5021747D	5021757D
3.5	5021718D	5021728D	5021738D	5021748D	5021758D
4.0	5021719D	5021729D	5021739D	5021749D	5021759D

Sales Unit (pcs.)	1
-------------------	---

SeQuent[®] NEO NC

Coronary Non-Compliant Balloon Catheter

Technical Data

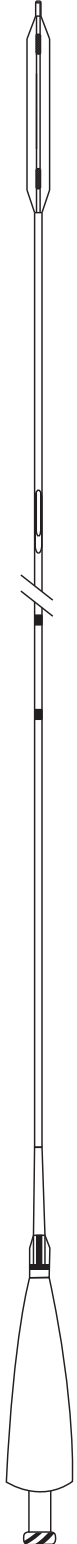

Delivery system	Rapid Exchange
Balloon material	Nylon
Proximal shaft	1.9 F
Distal shaft	2.7 F
Usable length	140 cm
Brachial & femoral marker	90 cm & 100 cm
Guiding catheter compatibility	5 F
Guide wire compatibility	0.014"
Lesion entry profile	0.016" (0.41 mm)
Balloon compliance	Non-compliant standard balloon
Nominal pressure (NP)	12 atm
Rated Burst Pressure (RBP)	20 atm

Balloon Diameter (mm)	Balloon Length (mm)					
	8	10	12	15	20	30
2.0	5023900	5023910	5023920	5023930	5023940	5023960
2.25	5023901	5023911	5023921	5023931	5023941	5023961
2.5	5023902	5023912	5023922	5023932	5023942	5023962
2.75	5023903	5023913	5023923	5023933	5023943	5023963
3.0	5023904	5023914	5023924	5023934	5023944	5023964
3.5	5023906	5023916	5023926	5023936	5023946	5023966
4.0	5023907	5023917	5023927	5023937	5023947	5023967
4.5	5023908	5023918	5023928	5023938	5023948	5023968

Sales Unit (pcs.)	1
-------------------	---

NSE Alpha™

Coronary Scoring Balloon Catheter for Complex Lesions

Technical Data



Delivery system	Rapid Exchange
Scoring elements	3
Material of the scoring elements	Nylon
Proximal shaft	2.1 F
Distal shaft	2.7 F
Usable length	143 cm
Brachial & femoral marker	93 cm & 103 cm
Guiding catheter compatibility	6 F
Guide wire compatibility	0.014"
Lesion entry profile	0.016"
Nominal pressure (NP)	6 atm
Rated Burst Pressure (RBP)	20 atm

Balloon Diameter (mm)	Balloon Length (13 mm)
2.0	NSA20013
2.25	NSA22513
2.5	NSA25013
2.75	NSA27513
3.0	NSA30013
3.5	NSA35013
4.0	NSA40013

Sales Unit (pcs.)	1
-------------------	---

Serpia®

Coronary Guiding Catheter

	5 French (Inner diameter: 0.058")		6 French (Inner diameter: 0.071")		7 French (Inner diameter: 0.082")	
	Configuration	Reference	Configuration	Reference	Configuration	Reference
- Usable length 100 cm	AL 0.75	25400105	AL 0.75	26400105	AL 1 SH	27400225
- Hydrophilic coated catheter shaft	AL 1	25400205	AL 0.75 SH	26400125	AL 2 SH	27400325
- Kissing balloon capable	HS	25401505	AL 1	26400205	AL 3 SH	27400425
- Atraumatic tip	JL 3.5	25402105	AL 1 SH	26400225	AR 1 SH	27400525
	JL 4	25402205	AL 1.5	26401005	AR 2 SH	27400725
	JR 3.5	25402705	AL 1.5 SH	26401025	HS SH	27401525
	JR 4	25402805	AL 2	26400305	JL 3 SH	27402025
	MPA	25403605	AL 2 SH	26400325	JL 3.5 SH	27402125
	RAD	25405005	AR 1	26400505	JL 4 SH	27402225
	TIG4	25407005	AR 1 SH	26400525	JL 4.5 SH	27402325
	XB 3.5	25407505	AR 2	26400705	JL 5 SH	27402425
	XB 4	25407605	AR 2 SH	26400725	JR 3.5 SH	27402725
	EBU 3.5	25408805	HS	26401505	JR 4 SH	27402825
	EBU 3.75	25408905	IM	26401705	JR 4.5 SH	27402925
	EBU 4	25409005	IM SH	26401725	JR 5 SH	27403025
			JL 3	26402005	MPA SH	27403625
			JL 3 SH	26402025	EBU 3 SH	27408625
			JL 3.5	26402105	EBU 3.5 SH	27408825
			JL 3.5 SH	26402125	EBU 3.75 SH	27408925
			JL 4	26402205	EBU 4 SH	27409025
			JL 4 SH	26402225	EBU 4.5 SH	27409225
			JL 5	26402405		
			JL 5 SH	26402425		
			JR 3.5	26402705		
			JR 3.5 SH	26402725		
			JR 4	26402805		
			JR 4 SH	26402825		
			JR 4.5 SH	26402925		
			JR 5	26403005		
			MPA	26403605		
			MPA SH	26403625		
			RAD	26405005		
			RCB	26405505		
			TIG 4	26407005		
			XB 3	26407305		
			XB 3.5	26407505		
			XB 3.5 SH	26407525		
			XB 4	26407605		
			XB 4 SH	26407625		
			XB 4.5	26407705		
			EBU 3	26408605		
			EBU 3 SH	26408625		
			EBU 3.5	26408805		
			EBU 3.5 SH	26408825		
			EBU 3.75 SH	26408925		
			EBU 4	26409005		
			EBU 4 SH	26409025		



Accessories for PTCA

Metal Insertion Tool, Torquer, Y-Connector, Unique Kissing BiBalloon Adaptor

	Gauge	Length (mm)	Color	Code-Number	Sales Unit (pcs.)
--	-------	-------------	-------	-------------	-------------------



Metal Insertion Tool

20	100	Transparent	5017826	20
----	-----	-------------	----------------	----

	Code-Number	Sales Unit (pcs.)
--	-------------	-------------------

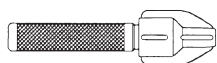

Torquer

The torquer is designed for guide wires.
 – Wire grip for all diameters up to 0.022"

Torquer	5023687	10
---------	----------------	----

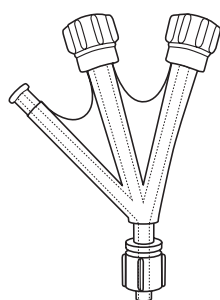

Y-Connector

– With rotational adaptor and Tuohy-Borst-valve
 – 9.5 F lumen

Y-connector with plastic insertion tool	5021693	10
Double Y-connector with plastic insertion tool	5020743	5

Unique Kissing BiBalloon Adaptor

The product enables the simultaneous inflation of two devices to perform interventional procedures (e.g. coronary bifurcation procedure)

Unique Kissing BiBalloon Adaptor	5014760	25
----------------------------------	----------------	----

Accessories for PTCA

Inflation Device, Fluid Collection System

Inflation Device for PTCA	Code-Number	Sales Unit (pcs.)
---------------------------	-------------	-------------------

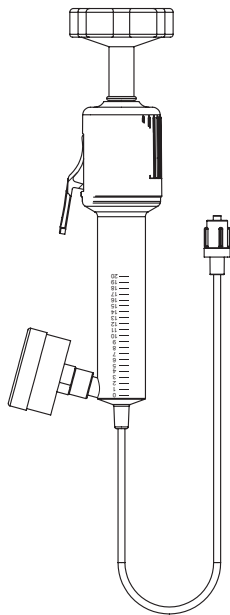

This inflation device is a component in PTCA-Kit 3 and PTCA-Kit 4 presented on the next page.

- **Pressure Gauge**
 - 90° rotating manometer
 - Coded figures from nominal to burst pressures
- **Body and Handle**
 - Ergonomic handle
 - Clear material for air detection and de-bubbling

Inflation device for PTCA, 20 ml/30 atm	5028901	1
---	----------------	---

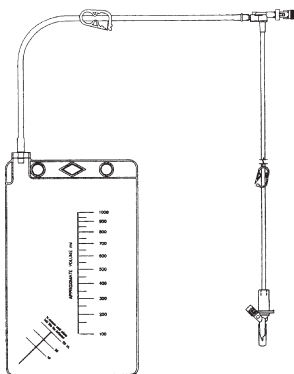

Fluid Collection System

- Aspiration of liquids (saline solution, contrast media)
- Disposal of aspiration liquid in a closed container (bag)
- Tubing length to dual check valve: 190 cm
- Tubing length to container: 180 cm
- Container volume: 1000 ml

Fluid collection system	5015879	50
-------------------------	----------------	----

Accessories for PTCA

PTCA-Kits, Bifurcation Kit

	Code- Number	Sales Unit (pcs.)
PTCA-Kit 2 – Y-connector with metal insertion tool – Torquer, wire grip for all diameters up to 0.022"		
PTCA-Kit 2	5028550	10
PTCA-Kit 3 – Y-connector with metal insertion tool – Torquer, wire grip for all diameters up to 0.022" – Inflation device for PTCA		
PTCA-Kit 3	5028902	1
PTCA-Kit 4 – Y-connector, insertion tool and torquer – High pressure 3-way stopcock – Inflation device for PTCA		
PTCA-Kit 4	5028905	1
Bifurcation Kit – Inflation device – Double Y-connector – Unique Kissing BiBalloon Adaptor – Insertion tool and torquer		
Bifurcation Kit	5028904	1

Angiographic Catheter

Diagnostic Catheters for Angiography

- High kink resistance
- Maximal control and excellent transmission due to symmetrically braided shaft
- Atraumatic rounded distal tip design
- Facilitated identification due to color coded French sizes

4 French (red)

	Selective	Pigtail
Outer diameter body & tip	0.055"/ 1.4 mm	0.055"/ 1.4 mm
Inner diameter body	0.042"/ 1.12 mm	0.042"/ 1.12 mm
Inner diameter tip	0.042"/ 1.07 mm	0.042"/ 1.07 mm

5 French (grey)





	Selective	Pigtail
Outer diameter body & tip	0.065"/ 1.65 mm	0.065"/ 1.65 mm
Inner diameter body	0.050"/ 1.27 mm	0.050"/ 1.27 mm
Inner diameter tip	0.047"/ 1.18 mm	0.042"/ 1.07 mm

6 French (green)

	Selective	Pigtail
Outer diameter body & tip	0.079"/ 2.0 mm	0.079"/ 2.0 mm
Inner diameter body	0.057"/ 1.44 mm	0.057"/ 1.44 mm
Inner diameter tip	0.057"/ 1.44 mm	0.042"/ 1.07 mm

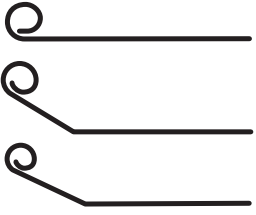
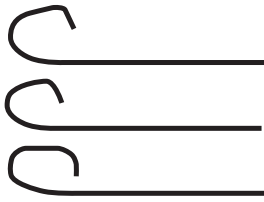
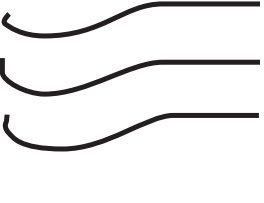

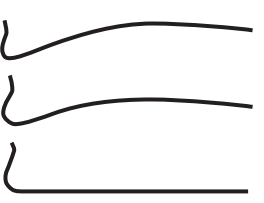

Angiographic Catheter

Diagnostic Catheters for Angiography

	Shape Description	Length (cm)	Code-Number 4 French	Code-Number 5 French	Code-Number 6 French	Sales Unit (pcs.)
	Pigtail - catheter for ventriculography - 8 sideholes					
	PIG	110	5011573	5011536	5011521	5
	PIG	130	5011592	5011527	5011526	5
	PIG 145	110	5011595	5011572	5011525	5
	PIG 145	130	5011577	5011503	5011569	5
	PIG 155	110	5011534	5011541	5011528	5
	PIG 155	130	5011532	5011557	5011502	5
	Judkins - catheter for the left coronary artery					
	JL 3.0	100	5011635	5011612	5011631	5
	JL 3.5	100	5011594	5011512	5011511	5
	JL 4.0	100	5011563	5011545	5011517	5
	JL 4.5	100	5011644	5011613	5011632	5
	JL 5.0	100	5011514	5011586	5011518	5
	JL 6.0	100	5011677	5011614	5011634	5
	Judkins - catheter for the right coronary artery					
	JR 3.0	100	5011688	5011615	5011650	5
	JR 3.5	100	5011588	5011535	5011589	5
	JR 4.0	100	5011500	5011546	5011508	5
	JR 4.5	100	5011699	5011617	5011649	5
	JR 5.0	100	5011576	5011558	5011509	5
	JR 6.0	100	5011600	5011618	5011636	5
	Amplatz - catheter for the left coronary artery					
	AL1	100	5011552	5011582	5011548	5
	AL2	100	5011599	5011565	5011550	5
	AL3	100	5011506	5011520	5011553	5
	Amplatz - catheter for the right coronary artery					
	AR1MOD	100	5011513	5011551	5011530	5
	AR2MOD	100	5011537	5011516	5011542	5
	ARMOD	100	5011522	5011529	5011547	5
	Multi Purpose catheter					
	MPA	100	5011501	5011561	5011564	5
	MPA2	100	5011580	5011540	5011556	5
	MPB	100	5011611	5011575	5011637	5
	MPB2	100	5011622	5011581	5011638	5

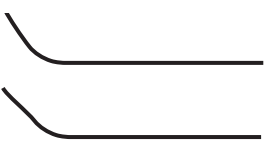
Angiographic Catheter

Diagnostic Catheters for Angiography

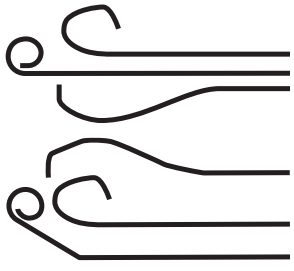
	Shape Description	Length (cm)	Code-Number 4 French	Code-Number 5 French	Code-Number 6 French	Sales Unit (pcs.)
	Williams					
	3DS	100	5011596	5011597	5011598	5
	Sones catheter - 2 sideholes					
	Sones1	100	5011603	5011619	5011639	5
	Sones1/2	100	5011539	5011570	5011554	5
	Sones2	100	5011604	5011621	5011640	5
	Sones2/2	100	5011111	5011593	5011559	5
	Gamal					
	Gamal	100	5011605	5011624	5011641	5
	Radial					
	RAD	100	5014444	5011543	5011544	5
	TIG2	100	5011606	5011625	5011642	5
	Bypass catheter					
	IM	100	5011533	5011505	5011562	5
	LCB	100	5012222	5011591	5011510	5
	RCB	100	5013333	5011560	5011519	5
	Duo-Pack					
	JL4/JR4	100/100	5011607	5011626	5011643	5
	JL4/3DS	100/100		5011712		5
	Multipack					
	JL4/JR3.5/PIG	100/100/110	5011609	5011628	5011646	5
	JL3.5/JR4/PIG145	100/100/110	5011608	5011627	5011645	5
	JL4/JR4/PIG	100/100/110	5011538	5011549	5011567	5
	JL4/JR4/PIG145	100/100/110	5014892	5011524	5011568	5
	3DS/JL4/PIG145	100/100/110	5011610	5011629	5011647	5
	ARMOD/JL4/PIG145	100/100/110		5011630		5
	3DS/JL4/PIG	100/100/110			5011648	5

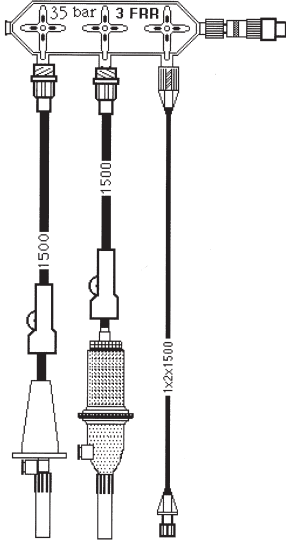
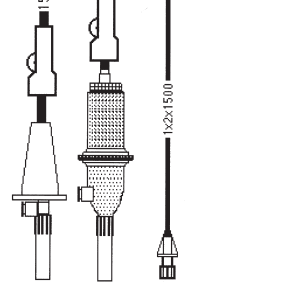
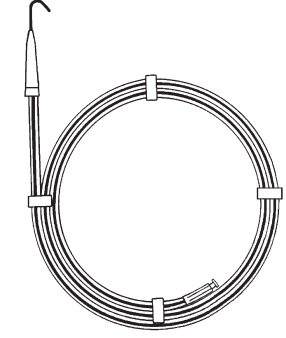
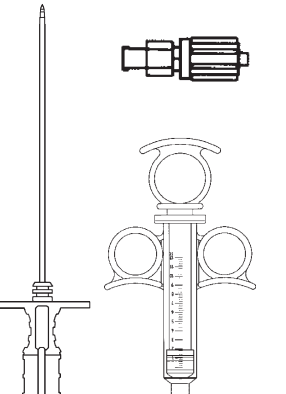
	Code-Number	Sales Unit (pcs.)
 <p>Manifold assembly 3-way, OFF</p> <ul style="list-style-type: none"> - High pressure manifold, 3-way, OFF, connected with contrast media tubing, Intrafix air and Combidyn tubing - Angiographic syringe 10 ml - Arterial puncture needle (Seldinger) 18 G - Cutfix scalpel Fig. 11 	5010660	25
 <p>Manifold assembly 2-way, OFF</p> <ul style="list-style-type: none"> - High pressure manifold, 2-way, OFF, connected with contrast media tubing and Combidyn tubing - Angiographic syringe 10 ml - Arterial puncture needle (Seldinger) 18 G - Cutfix scalpel Fig. 11 	5010440	25
 <p>Manifold assembly 3-way, ON</p> <ul style="list-style-type: none"> - High pressure manifold, 3-way, ON, connected with contrast media tubing, Intrafix air and Combidyn tubing - Angiographic syringe 10 ml - Arterial puncture needle (Seldinger) 18 G - Cutfix scalpel Fig. 11 	5010220	25
 <p>Angiography kit 3-way, OFF</p> <ul style="list-style-type: none"> - High pressure manifold, 3-way, OFF, connected with contrast media tubing, Intrafix air and Combidyn tubing - Angiographic syringe 10 ml - Arterial puncture needle (Seldinger) 18 G - Cutfix scalpel Fig. 11 - Angiographic drape with 2 transparent windows - Standard guide wire, 150 cm, J3-tip, 0.035" - Gauze, 10 x 10 cm, 12-ply - Sterican needle, G 21 green - Sterican needle, G 22 black - Omnifix syringe LL, 5 ml - Omnifix syringe LL, 10 ml - Tray, 27 x 22 x 4 cm - Cover drape 100 x 150 cm 	5010550	4

Angiodyn®

Standard Kits

	Code-Number	Sales Unit (pcs.)
Basic Set		
<ul style="list-style-type: none">- Nosebag 108 x 50 x 80 cm- Image intensifier cover 75 x 80 cm- Image intensifier cover 90 x 90 cm- Bowl transparent 500 ml- Universal clamp- Guide wire bowl blue 2500ml- Syringe Omnifix 10 ml, LL- Syringe Omnifix 10 ml, LS- Syringe Omnifix 5 ml, LS- Puncture needle 1,3 x 70 mm, 18G- Sterican 0,90 x 40 mm, 20G, yellow- Sterican 0,70 x 30 mm, 22G, black- Bowl 120 ml transparent- Bowl 250 ml transparent- Swab balls plum size- Gauze pad 10 x 10 cm- Coat size. XL- Angio drape 240 x 380 cm, 4 holes- Lamp cover- Guide wire J3FC-FS 150-035- Cutfix scalpel Fig. 11- Image intensifier cover 35 x 70 cm- Image intensifier cover 120 x 120 cm- Cover drape 150 x 90 cm- Cover drape 152 x 190 cm		
Basic Set	5014218	4
Add on Basic Kit		
<ul style="list-style-type: none">- Wrap drape 137 x 137 cm- Surgical drape 45 x 45 cm, 6-ply, with x-ray- Image intensifier cover 35 x 70 cm- Image intensifier bag 100 x 100 cm- Incision foil 30 x 26 cm- Tray 25,0 x 13,7 x 5,0 cm- Image intensifier cover 140 x 140 cm- Universal clamp- Cutfix scalpel Fig. 11		
Add on Basic Kit	5014219	10

Angiodyn®

Guide Wires, PTFE-Coated

Angiodyn® Guide Wires

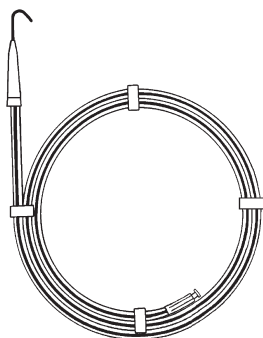

Guide wires for insertion, stabilization and positioning of angiographic catheters.

- PTFE-coated stainless nickel-chromium steel
- Flexible and rounded wire tip
- Straightener (only for J-tip)
- Standard: With dispenser and Luer Lock-fitting for flushing the wire

Product Description	Length (cm)	Diameter (inch/mm)	Code-Number	Sales Unit (pcs.)
J-tip, fixed core (FC), fingerstraightenable (FS)				
J3 FC-FS 150-035	150	0.035/0.89	5050200	10
J3 FC-FS 150-038	150	0.038/0.97	5050219	10
J3 FC-FS 175-035	175	0.035/0.89	5059755	50
J3 FC-FS 200-035	200	0.035/0.89	5050980	50
J3 FC-FS 220-035	220	0.035/0.89	5050981	50
J3 FC-FS 260-035	260	0.035/0.89	5050359	5
J3 FC-FS 260-038	260	0.038/0.97	5050367	5
Straight tip (S), fixed core (FC)				
SFC 150-018	150	0.018/0.46	5050456	10
SFC 150-035	150	0.035/0.89	5050243	10
SFC 150-038	150	0.038/0.97	5050251	10
SFC 260-038	260	0.038/0.97	5050430	5
J-tip, movable core (M), fingerstraightenable (FS)				
J3 MC-FS 150-032	150	0.032/0.81	5056470	10
J3 MC-FS 150-035	150	0.035/0.89	5050235	10
J3 MC-FS 200-035	200	0.035/0.89	5050308	10
J-tip and straight tip (S) (flexible on both ends) fixed core (FC), fingerstraightenable (FS)				
J3 SFC-FS 150-035	150	0.035/0.89	5050227	10
J3 SFC-FS 150-038	150	0.038/0.97	5051022	50
J3 SFC-FS 175-035	175	0.035/0.89	5059208	50
J3 SFC-FS 220-035	220	0.035/0.89	5050360	5

Mid and High Pressure Full-Body Manifolds

Angiodyn® Mid and High Pressure Full-Body Manifold

- Transparent housing for visual control
- Stopcocks tested up to 35 bar (500 psi) pressure stability for manual injections
- Without rotating adaptor but with female Luer Lock-fitting
- With rotating adaptor and male Luer Lock-fitting for catheter connection

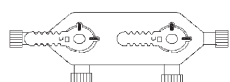

Manifolds 2-port ON version, grey handles

Pressure Stability (bar)	Connections	Description	Code-Number	Sales Unit (pcs.)
35	Rotating adaptor male right	2 OR 35	5012759	50
70	Rotating adaptor male right	2 ORR 70	5012783	50

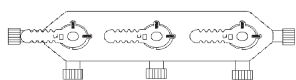

Manifolds 3-port ON version, grey handles

35	Rotating adaptor male right	3 ORR 35	5012813	50
70	Rotating adaptor male right	3 ORR 70	5012848	50

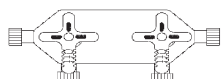

Manifolds 2-port OFF version, yellow handles

35	Rotating adaptor male right	2 FRR 35	5012112	50
70	All female	2 FF 70	5012015	50
70	Rotating adaptor male right	2 FRR 70	5012104	50

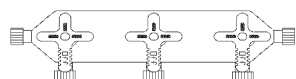

Manifolds 3-port OFF version, yellow handles

35	Rotating adaptor male right	3 FRR 35	5012074	50
70	Rotating adaptor male right	3 FRR 70	5012066	50

Angiodyn® Softgrip

Mid and High Pressure Full-Body Manifolds

Angiodyn® Mid and High Pressure Full-Body Manifold

- Transparent housing for visual control
- Stopcocks tested up to 35 bar (500 psi) pressure stability for manual injections
- With rotating adaptor and male Luer Lock-fitting for catheter connection
- Colored handles

Pressure Stability (bar)	Code-Number	Sales Unit (pcs.)
--------------------------	-------------	-------------------

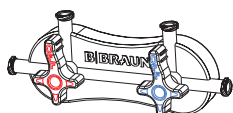

Manifold Softgrip 2-port OFF version

35	5011406	50
70	5010576	50

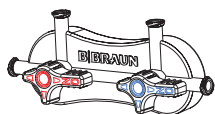

Manifold Softgrip 2-port ON version

35	5011407	50
70	5010577	50

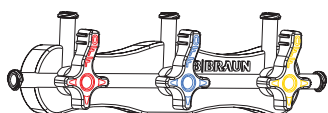

Manifold Softgrip 3-port OFF version

35	5011404	50
70	5010575	50

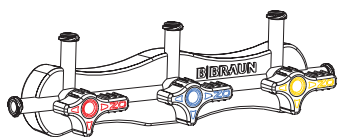

Manifold Softgrip 3-port ON version

35	5016131	50
70	5010579	50

Angiodyn®

High Pressure Tubing with / without Rotating Adaptor

Angiodyn® High Pressure Tubing

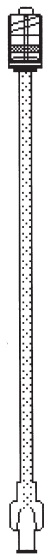

Angiodyn® High Pressure Tubing up to 84 bar (1200 psi)

– Braided PUR, very flexible

Male/Female with Rotating Adaptor

Length (cm)	Inner Diameter (mm)	Outer Diameter (mm)	Code-Number	Sales Unit (pcs.)
25	1.75	3.6	5018864	25
50	1.75	3.6	5011507	25
75	1.75	3.6	5011515	25
100	1.75	3.6	5011523	25
120	1.75	3.6	5011531	25
200	1.75	3.6	5016002	25

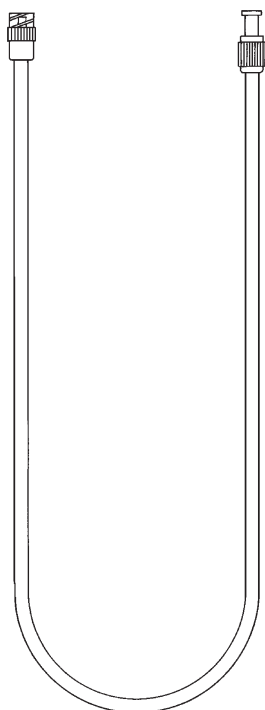

Angiodyn® High Pressure Tubing up to 70 bar (1000 psi)

– PVC, flexible

Male/Female with Rotating Adaptor

Length (cm)	Inner Diameter (mm)	Outer Diameter (mm)	Code-Number	Sales Unit (pcs.)
25	2.0	4.75	5014824	20
50	2.0	4.75	5011957	20
75	2.0	4.75	5011965	20
100	2.0	4.75	5011973	20
120	2.0	4.75	5011938	20
150	2.0	4.75	5018580	25
180	2.0	4.75	5218088	25

Male/Female without Rotating Adaptor

Length (cm)	Inner Diameter (mm)	Outer Diameter (mm)	Code-Number	Sales Unit (pcs.)
50	2.0	4.75	5018196	20
75	2.0	4.75	5018200	20
100	2.0	4.75	5018218	20
120	2.0	4.75	5018233	20
150	2.0	4.75	5014875	20

Spectraline Syringes/Contrast Saver Systems

Spectraline Disposable Syringes for Connection with Manifolds and Catheters

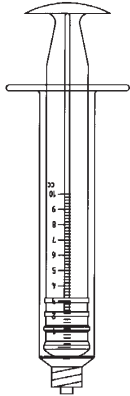

- For injection of contrast media, heparin, saline solution and other liquids by hand
- Transparent barrel provides visualization of fluid levels and air bubbles
- Ergonomic palm plunger
- 10 ml and 20 ml syringes available in five colors
- Each syringe is individually packaged with a label set

Plunger Color	Type	Syringe Volume (ml)	Code-Number	Sales Unit (pcs.)
White	SP 10 W	10	5018991	25
Blue	SP 10 B	10	5018993	25
Green	SP 10 G	10	5018996	25
Yellow	SP 10 Y	10	5018997	25
Red	SP 10 R	10	5018992	25
White	SP 20 W	20	5018998	25
Blue	SP 20 B	20	5019004	25
Green	SP 20 G	20	5019006	25
Yellow	SP 20 Y	20	5019013	25
Red	SP 20 R	20	5019016	25

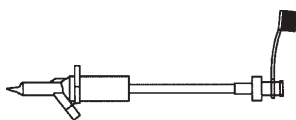

Contrast Saver System

- System for saving contrast media

Contrast Saver Spike

- Ventilated spike for contrast media container with Safesite valve
- Applicable for several angiographic examinations
- With integrated cover cap
- Length 15 cm

Contrast saver spike	5010557	50
----------------------	---------	----

Contrast Saver Tubing

- Connection between contrast saver spike and manifold
- With large bore check valve to close the contrast media container (to prevent contamination with micro organisms)
- Length 140 cm

Contrast saver tubing	5010552	50
Contrast saver burette (without illustration)	5012000	50



Angiodyn®

Angiographic Syringes / Injector Syringes

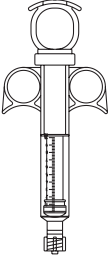
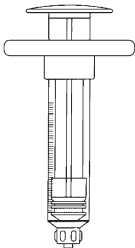
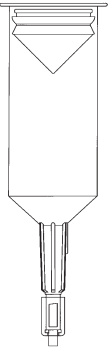
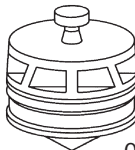
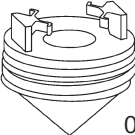
Angiodyn®		Code-Number	Sales Unit (pcs.)
	<p>Angiographic syringes perform contrast media injections.</p> <ul style="list-style-type: none"> - Rubber gasket for smooth plunger action with double seal - Crystal clear barrel <p>10 ml Angiographic Syringe with Rotating Adapter</p> <ul style="list-style-type: none"> - Ring plunger and medium sized grip plate - Security stop at 1.0 ml - Lateral finger rings 		
	10 ml angiographic syringe with rotating adapter	5011990	50
	<p>10 ml Angiographic Syringe with Male Luer Lock-Fitting</p> <ul style="list-style-type: none"> - Medium sized grip plate - Security stop at 1.0 ml 		
	10 ml angiographic syringe with male Luer Lock-fitting	5010142	50
	<p>Angiodyn® Injector Syringes</p> <ul style="list-style-type: none"> - Transparent material for visual inspection - Plunger with double seal prevents air aspiration and leakage - Protective cap - Connection to all Luer standards possible 		
	0137NE 150 ml Angiomat 6000 TM	5010200	50
	0137NF 150 ml Medrad (Mark V)	5010207	50
 <p>0137 NE</p>  <p>0137 NF</p>			
<p>Additional Tubing (without illustration)</p> <ul style="list-style-type: none"> - Facilitates filling contrast media into injection syringes 			
Additional tubing		5017000	100

Angiodyn®

Image Intensifier Covers and Bags

Angiodyn® Image Intensifier Covers and Bags

- Protect your equipment from contamination and dust
- PE transparent cover
- With elastic or string fixation

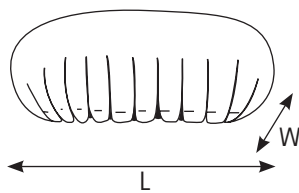

Angiodyn® Image Intensifier Cover with Elastic Fixation

Length = L (cm)	Width = W (cm)	Code- Number	Sales Unit (pcs.)
35	70	5014022	25
45	45	5016733	25
75	80	5010438	25
75	100	5010446	25
80	120	5213568	25
90	90	5017582	25
110	110	5015649	25
120	120	5010085	25
140	140	5018912	25

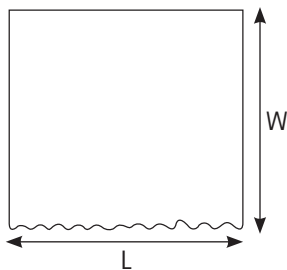

Angiodyn® Image Intensifier Bag with Elastic Fixation

60	60	5016080	25
80	45	5015210	25
80	100	5019520	25
85	90	5019900	25
90	60	5010210	25
90	100	5012629	25
100	100	5014983	25
110	130	5015640	25

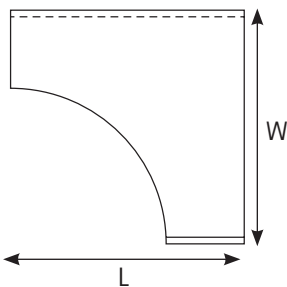

Angiodyn® Image Intensifier Bag (nose type)

80	80	5018100	50
82	95	5019430	50
117	90	5011179	50

Angiodyn® Bag with String Fixation

60	65	5017745	25
----	----	---------	----

Angiodyn® Lamp Handle Cover (without illustration)

		5016255	100
--	--	---------	-----

Angiodyn® Table Plastic Cover (without illustration) Color: Blue

60	65	5012606	25
----	----	---------	----

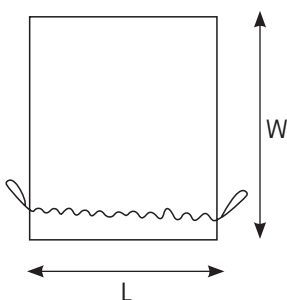

Angiodyn®

Image Intensifier Covers and Bags

	Length (cm)	Width (cm)	Code-Number	Sales Unit (pcs.)
--	-------------	------------	-------------	-------------------

Angiodyn® Protection Cover Radial

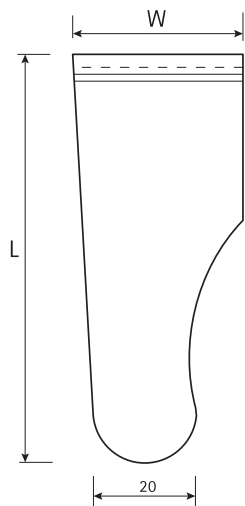

	86	41	5012119	50
--	----	----	---------	----

Angiodyn® Protection Cover Femoral

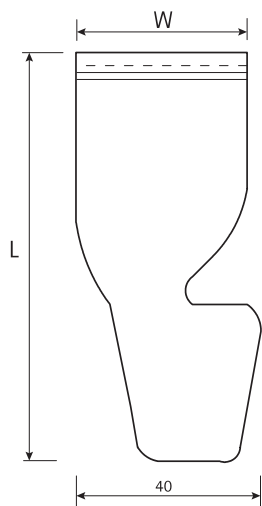

	86	40	5019113	50
--	----	----	---------	----

Angiodyn® Monitor Hand Cover (without illustration)

	160	30	5013308	50
--	-----	----	---------	----

Angiodyn® Remote Control Cover with Cord (without illustration)

	24	16	5010410	50
--	----	----	---------	----

Angiodyn® Camera Cover (without illustration)

	250	13	5012543	25
--	-----	----	---------	----

Intradyn® Arterial

Arterial Introducer, Guide Wire, Puncture Needle

Intradyn® Arterial	Code-Number	Sales Unit (pcs.)
--------------------	-------------	-------------------

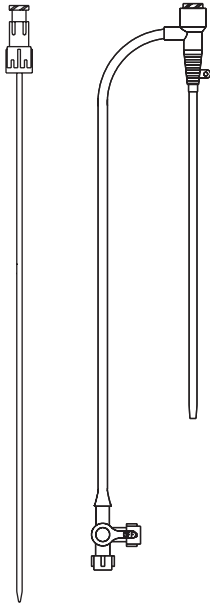

Introducer using the Seldinger technique according to Desilets Hofmann.

- **Guide Wire 40 cm**
 - Made of stainless steel, \varnothing 0.035" / 0.89 mm
 - Flexible J3-tip with insertion tool or flexible straight tip
- **Vessel Dilator 160 mm made of PE**
 - Flexible, minimal trauma to vessels
 - Smoothly tapered transition to guide wire
- **Sheath 110 mm made of FEP**
 - Thin-walled
 - Smoothly tapered transition to vessel dilator
 - Luer Lock connection
- **Hemostasis Valve**
 - To prevent retrograde blood flow
 - For arterial and venous application
 - Smoothly tapered transition for easy introduction of catheter
 - Sideport with three-way stopcock for easy administration of I.V. solutions and injection of medications

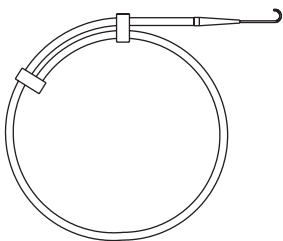

Intradyn® Arterial (with J3-guide wire)

F 4 red	5210033	20
F 5 grey	5210704	20
F 6 green	5210712	20
F 7 orange	5210720	20



Intradyn® Arterial Guide Wire

- With J3-tip and straightener
- 40 cm long, 0.035"
- In dispenser

J3 SFU-40-035	5050529	25
---------------	----------------	----

Intradyn® Arterial Puncture Needle (Seldinger)

- Smoothly tapered design for introduction of the guide wire up to max. \varnothing 0.035" (0.089 mm)
- Luer Lock-fitting

Gauge (G)	Diameter (mm)	Length (mm)	Color	Code-Number	Sales Unit (pcs.)
18	1.3	70	Light pink	5208505	50

Intradyn® Tear-Away

Tear-Away Introducer

Intradyn® Tear-Away	Code- Number	Sales Unit (pcs.)
---------------------	-----------------	----------------------

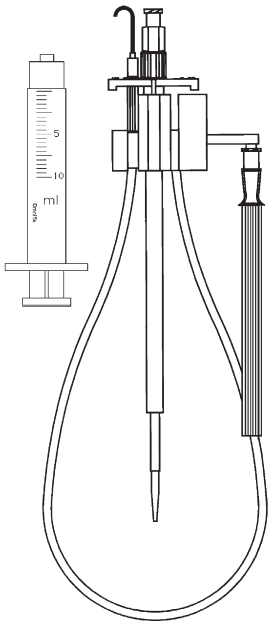

Tear-Away introducer sheath uses the Seldinger technique according to Desilets Hofmann.

- Pre-scored tearing line ensures clean and easy sheath removal after catheter placement
- Spin-lock connector holds dilatator and sheath together, preventing dilatator from backing out of sheath during vascular access

Intradyn® Tear-Away

- **Intradyn Puncture Needle According to Seldinger 1.3 x 70 mm (18 G)**
 - Made of stainless steel
 - Smoothly tapered hub transition for easy introduction of guide wire
- **Guide Wire 40 cm**
 - Made of stainless steel, \varnothing 0.035" / 0.89 mm
 - Flexible J3-tip and flexible straight tip
- **Vessel Dilatator 190 mm made of PE**
 - Flexible, minimal trauma to vessels
 - Smoothly tapered transition to guide wire
- **Introducer sheath 160 mm made of FEP (thin-walled)**
 - Smoothly tapered transition to vessel dilatator
- **Syringe Luer Lock-fitting 10 ml**

Intradyn® Tear-Away Introducer

F 6	5210313	20
F 7	5210593	20
F 8	5210321	20
F 9	5210330	20
F 10	5210348	20
F 11	5210585	20

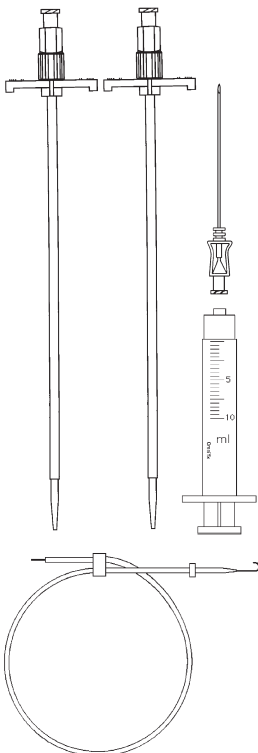

Intradyn® Dual Tear-Away Introducer

- Splittable introducer set with two sheaths for introduction of two probes for VDD- and DDD-pacemaker
- Same configuration as Intradyn Tear-Away, with two extra introducer sheaths and two dilatators

Intradyn® Dual Tear-Away Introducer

F 10	5212537	20
------	---------	----

More Brochures for our Products

Product brochures for



Coroflex® ISAR NEO
Ref. nr. 6050380

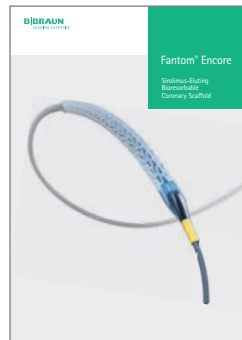

Fantom® Encore
Ref. nr. 6050336

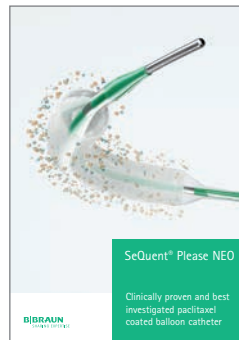

SeQuent® Please NEO
Ref. nr. 6050333



SeQuent® SCB
Ref. nr. 6050335



SeQuent® NEO
Ref. nr. 6050270



SeQuent® NEO NC
Ref. nr. 6050412



NSE Alpha™
Ref. nr. 6050328



**Clinical Evidence
NSE Alpha™**
Ref. nr. 6050319



**Clinical Evidence
Coroflex® ISAR NEO &
SeQuent® Please NEO**
Ref. nr. 6050318

Get in Touch with our Experts



Please scan the QR-Code and fill out the contact formular if you would like to be contacted from our experts.

Distributor

B. Braun Melsungen AG | Sieversufer 8 | 12359 Berlin | Germany
Phone +49 30 568207-300 | Fax +49 30 568207-210 | www.bbraun.com

Manufacturer acc. to MDD 93/42/EEC

B. Braun Melsungen AG | Carl-Braun-Str. 1 | 34212 Melsungen | Germany

Exceptions:

NSE Alpha is manufactured by Goodman Co. Ltd., Japan | Angiographic Catheters and Serpia are manufactured by PendraCare International B.V., The Netherlands



Information according to Regulation (EU) 2017/745 and Council Directive 93/42/EEC respectively:

Manufacturer of Product Fantom® Encore:

REVA Medical, LLC | 5751 Copley Drive | San Diego, CA, 92111 | United States of America



Distributor of Product Fantom® Encore:

B. Braun Melsungen AG | Vascular Systems | Sieversufer 8 | 12359 Berlin | Germany
Phone +49 30 568207-300 | Fax +49 30 568207-130 | www.bbraun.com



Importer of Product Fantom® Encore:

REVA Medical GmbH | Stichlingstrasse 1 | 60327 Frankfurt am Main | Germany



European Authorized Representative of Product Fantom® Encore:

REVA Medical GmbH | Stichlingstrasse 1 | 60327 Frankfurt am Main | Germany

The product trademarks 'SeQuent', 'Coroflex', 'Intradyn' and 'Angiodyn' are registered trademarks of B. Braun Melsungen AG. NSE Alpha is a registered trademark of Goodman Co. Ltd., Japan. Serpia is a registered trademark of PendraCare International B.V., The Netherlands. Fantom® and Fantom® Encore have the CE mark only. Fantom® and Fantom® Encore are available in selected countries that accept the CE mark. Fantom® and Fantom® Encore are not available in the U.S. or in countries that do not accept the CE mark. "Fantom" and "Tyrocore" are trademarks of REVA Medical, LLC. Specifications are subject to change without notice.

Subject to technical changes. All rights reserved. This brochure may only be used for the exclusive purpose of obtaining information about our products. Reproduction in any form partial or otherwise is not permitted.